



## ETSI EN 301 489 TEST REPORT

<b>Applicant</b>	:	Harman International Industries, Inc.
<b>Address of Applicant</b>	:	8500 Balboa Boulevard, Northridge, CA 91329, UNITED STATES
<b>Manufacturer</b>	:	Harman International Industries, Inc.
<b>Address of Manufacturer</b>	:	8500 Balboa Boulevard, Northridge, CA 91329, UNITED STATES
<b>Equipment under Test</b>	:	PORTABLE BLUETOOTH SPEAKER
<b>Model No.</b>	:	GO5, GO5D
<b>Test Standard(s)</b>	:	ETSI EN 301 489-1 V2.2.3 (2019-11) ETSI EN 301 489-17 V3.3.1 (2024-09)
<b>Report No.</b>	:	DDT-RE25091711-2E03
<b>Issue Date</b>	:	2025/11/04
<b>Issued By</b>	:	Guangdong Dongdian Testing Service Co., Ltd. Unit 2, Building 1, No. 17, Zongbu 2nd Road, Songshan Lake Park, Dongguan, Guangdong, China, 523808

# REPORT

## Table of Contents

1.	Summary of Test Results .....	7
2.	General Test Information.....	10
2.1.	Description of EUT .....	10
2.2.	Accessories of EUT .....	10
2.3.	Block diagram EUT configuration for test.....	11
2.4.	Decision of final test mode .....	12
2.5.	Deviations of test standard .....	12
2.6.	Test environment conditions .....	12
2.7.	Test laboratory .....	13
2.8.	Measurement uncertainty .....	14
3.	AC Power Port Conducted Emission.....	15
3.1.	Test equipment.....	15
3.2.	Block diagram of test setup .....	15
3.3.	Limits .....	16
3.4.	Assistant equipment used for test .....	16
3.5.	Test procedure .....	16
3.6.	Test result.....	17
3.7.	Test data .....	18
3.8.	Test photo .....	26
4.	Radiated Emissions Test.....	27
4.1.	Test equipment.....	27
4.2.	Block diagram of test setup .....	28
4.3.	Limits .....	31
4.4.	Assistant equipment used for test .....	31
4.5.	Test procedure .....	31
4.6.	Test result.....	32
4.7.	Test data .....	33
4.8.	Test photo .....	57
5.	Voltage Fluctuations& Flicker Test.....	58
5.1.	Test equipment.....	58
5.2.	Block diagram of test setup .....	58
5.3.	Test levels and performance criterion .....	58
5.4.	Assistant equipment used for test .....	59
5.5.	Test procedure .....	59
5.6.	Test result.....	59
5.7.	Test data .....	60

5.8.	Test photo .....	65
6.	Electrostatic Discharge Test.....	66
6.1.	Test equipment.....	66
6.2.	Block diagram of test setup .....	66
6.3.	Test levels and performance criterion .....	66
6.4.	Assistant equipment used for test .....	67
6.5.	Test procedure .....	67
6.6.	Test result.....	68
6.7.	ESD test points.....	70
6.8.	Test photo .....	71
7.	Continuous Radio Frequency Disturbances Test.....	72
7.1.	Test equipment.....	72
7.2.	Block diagram of test setup .....	72
7.3.	Test levels and performance criterion .....	73
7.4.	Assistant equipment used for test .....	74
7.5.	Test procedure .....	74
7.6.	Test result.....	75
7.7.	Test photo .....	77
8.	Electrical Fast Transients(EFT) Test.....	78
8.1.	Test equipment.....	78
8.2.	Block diagram of test setup .....	78
8.3.	Test levels and performance criterion .....	79
8.4.	Assistant equipment used for test .....	79
8.5.	Test procedure .....	79
8.6.	Test result.....	80
8.7.	Test photo .....	81
9.	Surge Test.....	82
9.1.	Test equipment.....	82
9.2.	Block diagram of test setup .....	82
9.3.	Test levels and performance criterion .....	82
9.4.	Assistant equipment used for test .....	83
9.5.	Test procedure .....	83
9.6.	est result.....	84
9.7.	Test photo .....	85
10.	Continuous Conducted Disturbances Test.....	86
10.1.	Test equipment.....	86
10.2.	Block diagram of test setup .....	86
10.3.	Test levels and performance criterion .....	87

10.4.	Assistant equipment used for test .....	87
10.5.	Test procedure .....	87
10.6.	Test result.....	88
10.7.	Test photo .....	88
11.	Voltage Dips and Interruptions Test .....	89
11.1.	Test equipment.....	89
11.2.	Block diagram of test setup .....	89
11.3.	Test levels and performance criterion .....	89
11.4.	Assistant equipment used for test .....	90
11.5.	Test procedure .....	90
11.6.	Test result.....	90
11.7.	Test photo .....	92
12.	Sample photos .....	93

## Test Report Declare

<b>Applicant</b>	:	Harman International Industries, Inc.
<b>Address</b>	:	8500 Balboa Boulevard, Northridge, CA 91329, UNITED STATES
<b>Manufacturer</b>	:	Harman International Industries, Inc.
<b>Address</b>	:	8500 Balboa Boulevard, Northridge, CA 91329, UNITED STATES
<b>Equipment under Test</b>	:	PORTABLE BLUETOOTH SPEAKER
<b>Model No.</b>	:	GO5, GO5D

**Test Standard Used:**



ETSI EN 301 489-1 V2.2.3 (2019-11)

ETSI EN 301 489-17 V3.3.1 (2024-09)

**We Declare:**

The equipment described above is tested by Guangdong Dongdian Testing Service Co., Ltd. and in the configuration tested the equipment complied with the standards specified above. The test results are contained in this test report and Guangdong Dongdian Testing Service Co., Ltd. is assumed of full responsibility for the accuracy and completeness of these tests.

<b>Report No.:</b>	DDT-RE25091711-2E03		
<b>Date of Receipt:</b>	2025/09/30	<b>Date of Test:</b>	2025/09/30-2025/10/23

Created: Lori Mi	Reviewed: Caesar Peng	Approved: Damon Hu
		
2025/10/23	2025/11/04	2025/11/04

Note: This report applies to above tested sample only. This report shall not be reproduced in parts without written approval of Guangdong Dongdian Testing Service Co., Ltd.

## Revision History

Version	Revision Content	Issue Date	Approved
V0	Initial issue	2025/11/04	Damon Hu

## 1. Summary of Test Results

EMISSION (EMI)			
Description of Test Item	Standard	Result	Memo
AC Power Port Conducted Emission	ETSI EN 301 489-1 V2.2.3 (2019-11), ETSI EN 301 489-17 V3.3.1 (2024-09)	PASS	/
DC Power Port Conducted Emission	ETSI EN 301 489-1 V2.2.3 (2019-11), ETSI EN 301 489-17 V3.3.1 (2024-09)	N/A	Vehicle Use
Wired network port Conducted Emission	ETSI EN 301 489-1 V2.2.3 (2019-11), ETSI EN 301 489-17 V3.3.1 (2024-09)	N/A	For signal port
Radiated Emissions Test	ETSI EN 301 489-1 V2.2.3 (2019-11), ETSI EN 301 489-17 V3.3.1 (2024-09)	PASS	/
Harmonic Current Emissions Test	ETSI EN 301 489-1 V2.2.3 (2019-11), ETSI EN 301 489-17 V3.3.1 (2024-09)	N/A	For AC power port ( $\leq 16A$ ), According to IEC 61000-3-2 Clause 7, this product belongs to exceptions of Clause 7 or Annex C. limits are not specified in this standard.
Voltage Fluctuations& Flicker Test	ETSI EN 301 489-1 V2.2.3 (2019-11), ETSI EN 301 489-17 V3.3.1 (2024-09)	PASS	/
IMMUNITY (EMS)			
Description of Test Item	Standard	Result	Memo
Electrostatic Discharge Test	ETSI EN 301 489-1 V2.2.3 (2019-11), ETSI EN 301 489-17 V3.3.1 (2024-09)	PASS	/
Continuous Radio Frequency Disturbances Test	ETSI EN 301 489-1 V2.2.3 (2019-11), ETSI EN 301 489-17 V3.3.1 (2024-09)	PASS	/
Electrical Fast Transients(EFT) Test	ETSI EN 301 489-1 V2.2.3 (2019-11), ETSI EN 301 489-17 V3.3.1 (2024-09)	PASS	/
Surge Test	ETSI EN 301 489-1 V2.2.3 (2019-11), ETSI EN 301 489-17 V3.3.1 (2024-09)	PASS	/

Continuous Conducted Disturbances Test	ETSI EN 301 489-1 V2.2.3 (2019-11), ETSI EN 301 489-17 V3.3.1 (2024-09)	PASS	/
Voltage Dips and Interruptions Test	ETSI EN 301 489-1 V2.2.3 (2019-11), ETSI EN 301 489-17 V3.3.1 (2024-09)	PASS	/
Transients and Surge for DC Port Test	ETSI EN 301 489-1 V2.2.3 (2019-11), ETSI EN 301 489-17 V3.3.1 (2024-09)	N/A	Vehicle Use

Note: N/A is an abbreviation for Not Applicable, and means this item is not applicable for this device or no need to test according to standard.

Note: 1. The EMI measurements had been made in the operating mode producing the largest emission in the frequency band being investigated consistent with normal applications.

An attempt had been made to maximize the emission by varying the configuration of the EUT.

2. The EMS measurements had been made in the frequency bands being investigated, with the EUT in the most susceptible operating mode consistent with normal applications. The configuration of the test sample had been varied to achieve maximum susceptibility.

Remark: Performance criteria:

Criteria	During test	After test (i.e. as a result of the application of the test)
A	Shall operate as intended. (see note). Shall be no loss of function. Shall be no unintentional transmissions.	Shall operate as intended. Shall be no degradation of performance. Shall be no loss of function. Shall be no loss of critical stored data.
B	May be loss of function.	Functions shall be self-recoverable. Shall operate as intended after recovering. Shall be no loss of critical stored data.
C	May be loss of function.	Functions shall be recoverable by the operator. Shall operate as intended after recovering. Shall be no loss of critical stored data.
NOTE: Operate as intended during the test allows a level of degradation in accordance with Minimum performance level. For equipment that supports a PER or FER, the minimum performance level shall be a PER or FER less than or equal to 10 %. For equipment that does not support a PER or a FER, the minimum performance level shall be no loss of the wireless transmission function needed for the intended use of the equipment.		

**Performance criteria for continuous phenomena:**

The performance criteria A shall apply.

During the test, the equipment shall:

- continue to operate as intended;
- not unintentionally transmit;
- not unintentionally change its operating state;
- not unintentionally change critical stored data.

**Performance criteria for Transient phenomena:**

The performance criteria B shall apply.

For all ports and transient phenomena with the exception described below, the following applies:

- The application of the transient phenomena shall not result in a change of the mode of operation (e.g. unintended transmission) or the loss of critical stored data.
- After application of the transient phenomena, the equipment shall operate as intended.

For surges applied to symmetrically operated wired network ports intended to be connected directly to outdoor lines the following criteria applies:

- For products with only one symmetrical port intended for connection to outdoor lines, loss of function is allowed, provided the function is self-recoverable, or can be otherwise restored.

Information stored in non-volatile memory, or protected by a battery backup, shall not be lost.

- For products with more than one symmetrical port intended for connection to outdoor lines, loss of function on the port under test is allowed, provided the function is self-recoverable. Information stored in non-volatile memory, or protected by a battery backup, shall not be lost.

## 2. General Test Information

### 2.1. Description of EUT

EUT* Name	: PORTABLE BLUETOOTH SPEAKER
Model Number	: GO5, GO5D
Difference of model number	: Above models are identical in schematic and structure, only the model number are different, therefore the test performed on the model GO5D.
EUT Function Description	: Please reference user manual of this device
Power Supply	: DC 5V/1.0A from external AC Adapter DC 3.85V 1000mAh Polymer Li-ion built-in battery
Hardware Version	: VerD
Software Version	: v25.38.12
Radio Specification	: Bluetooth BR/EDR/LE
Operation Frequency	: 2402 MHz to 2480 MHz
Modulation	: GFSK, $\pi/4$ -DQPSK, 8DPSK
Antenna Type	: PCB Antenna
Max Antenna Gain(dBi)	: 2.3
Sample Number	: S25091711-003

Note 1: EUT is the abbreviation of equipment under test.

Note 2: “☑” means to be chosen or applicable; “☐” means don’t to be chosen or not applicable; This note applies to entire report.

Note 3: Equipment meeting Class A requirements may not offer adequate protection to broadcast services within a residential environment; The Class B requirements for equipment are intended to offer adequate protection to broadcast services within the residential environment. Equipment compliant with the class A requirements should have a warning notice in the user manual stating that it could cause radio interference. For example, Warning: Operation of this equipment in a residential environment could cause radio interference.

### 2.2. Accessories of EUT

Accessories	Manufacturer	Model number	Description
N/A	N/A	N/A	N/A

### 2.3. Block diagram EUT configuration for test

Mode 1:Bluetooth + TWS mode

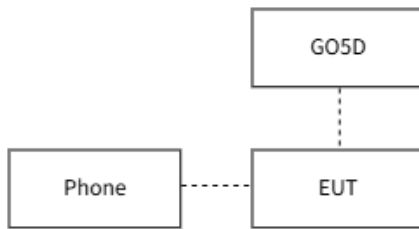

Mode 2:Bluetooth mode



Mode 3:Charging + Bluetooth mode



Mode 4:Charging + Bluetooth + TWS mode

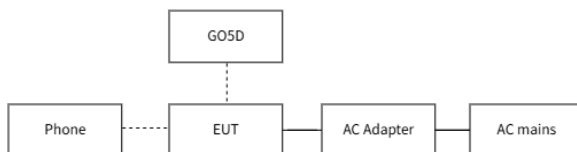

Test mode description: Phone playing 1 kHz sine audio signal and input to EUT.

Note: According exploration test, adjust the volume of EUT radiated the maximum emissions.

## 2.4. Decision of final test mode

Emission	AC Power Port Conducted Emission	Mode 3: Charging + Bluetooth mode Mode 4: Charging + Bluetooth + TWS mode
	Radiated Emissions Test	Mode 1: Bluetooth + TWS mode Mode 2: Bluetooth mode Mode 3: Charging + Bluetooth mode Mode 4: Charging + Bluetooth + TWS mode
	Voltage Fluctuations& Flicker Test	Mode 3: Charging + Bluetooth mode Mode 4: Charging + Bluetooth + TWS mode
Immunity	Electrostatic Discharge Test	Mode 1: Bluetooth + TWS mode Mode 2: Bluetooth mode Mode 3: Charging + Bluetooth mode Mode 4: Charging + Bluetooth + TWS mode
	Continuous Radio Frequency Disturbances Test	Mode 1: Bluetooth + TWS mode Mode 2: Bluetooth mode Mode 3: Charging + Bluetooth mode Mode 4: Charging + Bluetooth + TWS mode
	Electrical Fast Transients(EFT) Test	Mode 3: Charging + Bluetooth mode Mode 4: Charging + Bluetooth + TWS mode
	Surge Test	Mode 3: Charging + Bluetooth mode Mode 4: Charging + Bluetooth + TWS mode
	Continuous Conducted Disturbances Test	Mode 3: Charging + Bluetooth mode Mode 4: Charging + Bluetooth + TWS mode
	Voltage Dips and Interruptions Test	Mode 3: Charging + Bluetooth mode Mode 4: Charging + Bluetooth + TWS mode

## 2.5. Deviations of test standard

No deviation.

## 2.6. Test environment conditions

During the measurement the environmental conditions were within the listed ranges:

Temperature range:	20-25°C
Humidity range:	40-75%
Pressure range:	86-106 kPa

Note: The specific temperature and humidity information of each test item refers to the temperature and humidity record in the corresponding test data.

## 2.7. Test laboratory

Guangdong Dongdian Testing Service Co., Ltd.

Add.: Unit 2, Building 1, No. 17, Zongbu 2nd Road, Songshan Lake Park, Dongguan, Guangdong, China, 523808.

Tel.: +86-0769-38826678, <http://www.dgddt.com>, Email: [ddt@dgddt.com](mailto:ddt@dgddt.com).

CNAS Accreditation No. L6451; A2LA Accreditation Number: 3870.01

FCC Designation Number: CN1182, Test Firm Registration Number: 540522

Innovation, Science and Economic Development Canada Site Registration Number: 10288A<sup>®</sup>

Conformity Assessment Body identifier: CN0048

VCCI facility registration number: C-20087, T-20088, R-20123, R-20240, G-20118

## 2.8. Measurement uncertainty

Test Item	Uncertainty
Conducted disturbance at mains terminals	1#: 3.72dB (9 kHz to 150 kHz), 3.34dB (150 kHz to 30 MHz)
	2#: 3.75dB (9 kHz to 150 kHz), 3.39dB (150 kHz to 30 MHz)
	3#: 3.78dB (9 kHz to 150 kHz), 3.37dB (150 kHz to 30 MHz)
Uncertainty for telecommunication port conduction emission test	1#: AAN with aLCL = 55 ... 40 dBc: 3.64 dB AAN with aLCL = 65 ... 50 dBc: 4.08 dB AAN with aLCL = 75 ... 60 dBc: 4.56 dB
	2#: AAN with aLCL = 55 ... 40 dBc: 3.82 dB AAN with aLCL = 65 ... 50 dBc: 3.96 dB AAN with aLCL = 75 ... 60 dBc: 4.12 dB
Uncertainty for radiation emission test (30 MHz-1 GHz)	1#: 4.94 dB (Antenna Polarize: V) 4.68 dB (Antenna Polarize: H)
	2#: 4.94 dB (Antenna Polarize: V) 4.68 dB (Antenna Polarize: H)
	3#: 4.96 dB (Antenna Polarize: V) 4.98 dB (Antenna Polarize: H)
	10m: 4.48 dB (Antenna Polarize: V) 4.64 dB (Antenna Polarize: H)
Uncertainty for radiation disturbance test (1 GHz to 6 GHz)	1#: 4.10 dB (1-6 GHz)
	3#: 4.54 dB (1-6 GHz)
Uncertainty for Flicker test	0.2%
Uncertainty for Harmonic test	5%
Uncertainty for Electrostatic discharge	Rise time: 4% Peak current: 3.1% Current at 30 ns: 3.1% Current at 60 ns: 3.1%
Uncertainty for Surge	Peak of the open-circuit voltage impulse: 3% Front time of the open-circuit voltage impulse: 5% Width of the open-circuit voltage impulse: 5% Peak of the short-circuit current impulse: 2.7% Front time of the short-circuit current impulse: 5% Duration of the short-circuit current impulse: 3%
Uncertainty for Electrical fast transients	Voltage rise time: 3.7% Peak voltage value: 3.4% Voltage pulse width: 3.7%
Uncertainty for Continuous conducted disturbances	0.25dB
Uncertainty for Continuous radio frequency disturbances	1.12dB
Uncertainty for Power-frequency magnetic fields	10%
Uncertainty for Voltage dips and interruptions	3.7%
Temperature	0.4 °C
Humidity	2%
Note: This uncertainty represents an expanded uncertainty expressed at approximately the 95% confidence level using a coverage factor of k=2.	

### 3. AC Power Port Conducted Emission

#### 3.1. Test equipment

Equipment	Manufacturer	Model No.	Equipment No.	Cal Due To
EMI Test Receiver	R&S	ESCI	DDT-ZC00235	2026/07/06
Two Line V-Network	R&S	ENV216	DDT-ZC00535	2026/07/06
Artificial mains	R&S	ESH2-Z5	DDT-ZC00538	2026/07/06
Pulse Limiter	SCHWARZBEC K	ESH3-Z2	DDT-ZC00539	2026/07/06
CE Cable 1	R&S	ESU8/RF2	DDT-ZC00566	2026/07/06
Conducted Radiated Software	Audix	E3	DDT-ZC00562	/

#### 3.2. Block diagram of test setup

For table-top equipment

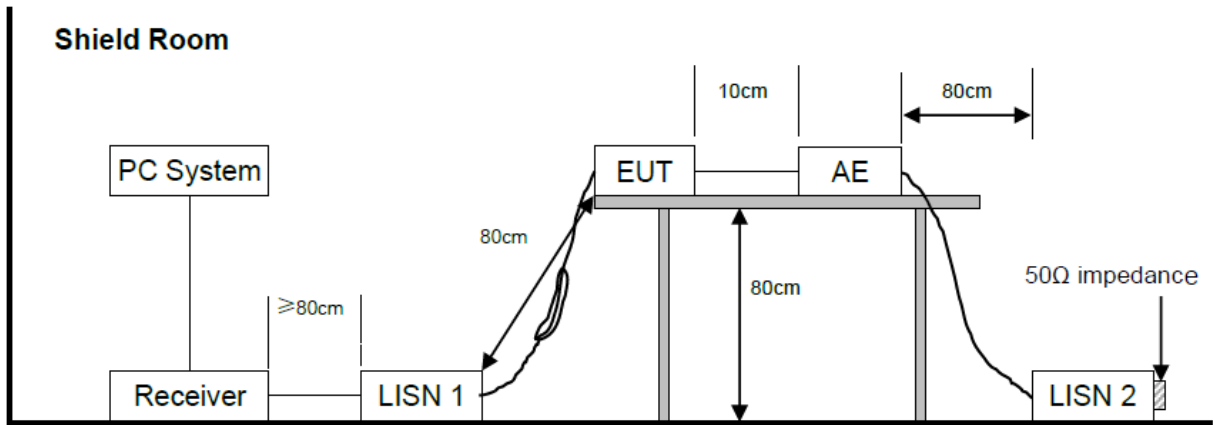

For floor standing equipment

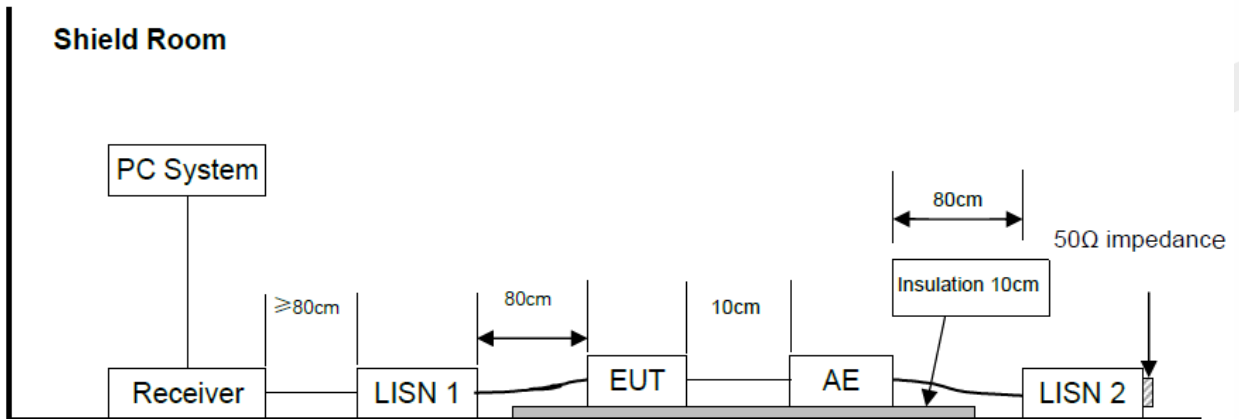

For combinations equipment

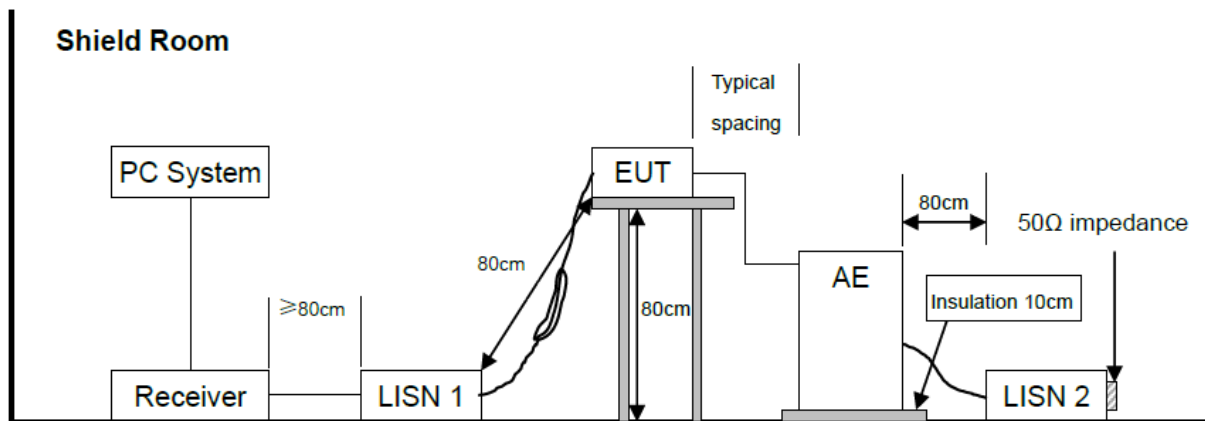

### 3.3. Limits

Class A		
Frequency	Quasi-Peak Level dB( $\mu\text{V}$ )	Average Level dB( $\mu\text{V}$ )
150 kHz~500 kHz	79	66
500 kHz~30 MHz	73	60
Class B		
Frequency	Quasi-Peak Level dB( $\mu\text{V}$ )	Average Level dB( $\mu\text{V}$ )
150 kHz~500 kHz	66 ~ 56*	56 ~ 46*
500 kHz~5 MHz	56	46
5 MHz~30 MHz	60	50

Notes:

- \* Decreasing linearly with logarithm of frequency.
- The lower limit shall apply at the transition frequencies.

### 3.4. Assistant equipment used for test

Assistant equipment	Manufacturer	Model number	Description	other
Phone	HUAWEI	MATE 20	N/A	N/A
Adapter	HUAWEI	HW110600C02	N/A	N/A
PORTABLE BLUETOOTH SPEAKER	Harman	GO5D	N/A	N/A
USB cable	N/A	N/A	Length: 1m	N/A

### 3.5. Test procedure

- (1) The EUT placement requires reference to the test block diagram and is placed on a non-metallic table.
- (2) Setup the EUT and assistant equipment as shown above block diagram and equipment list.

- (3) The EUT's power was connected to the power mains through a line impedance stabilization network (L.I.S.N). which this provided a 50-ohm coupling impedance for the EUT (Please refer to the block diagram of the test setup and photographs). Both sides of power line were checked for maximum conducted disturbance. In order to find the maximum emission, the relative positions of equipment and all of the interface cables were changed according to ETSI EN 301 489 on conducted disturbance emission test.
- (4) The bandwidth of test receiver is set at 9 kHz.
- (5) The frequency range from 150 kHz to 30 MHz is checked.

### 3.6. Test result

**Pass.** (See below detailed test result)

Note 1: All emissions not reported below are too low against the prescribed limits.

Note 2: "----" means Peak detection; "----" means Average detection.

3.7. Test data

## TR-4-E-010 Conducted Emission Test Result

**Test Site** : DDT 1# Shield Room D:\2025 CE report data\Q25091711-2E\0930 CE.EM6  
**Test Date** : 2025-09-30 **Tested By** : Alex Liu  
**EUT** : PORTABLE BLUETOOTH SPEAKER **Model Number** : GO5D  
**Power Supply** : AC 120V/60Hz **Test Mode** : Charging + Bluetooth mode  
**Condition** : TEMP:22.3°C, RH:61.1% **LISN** : 2025 1# 216/LINE  
**Memo** : S25091711-003

Data: 10

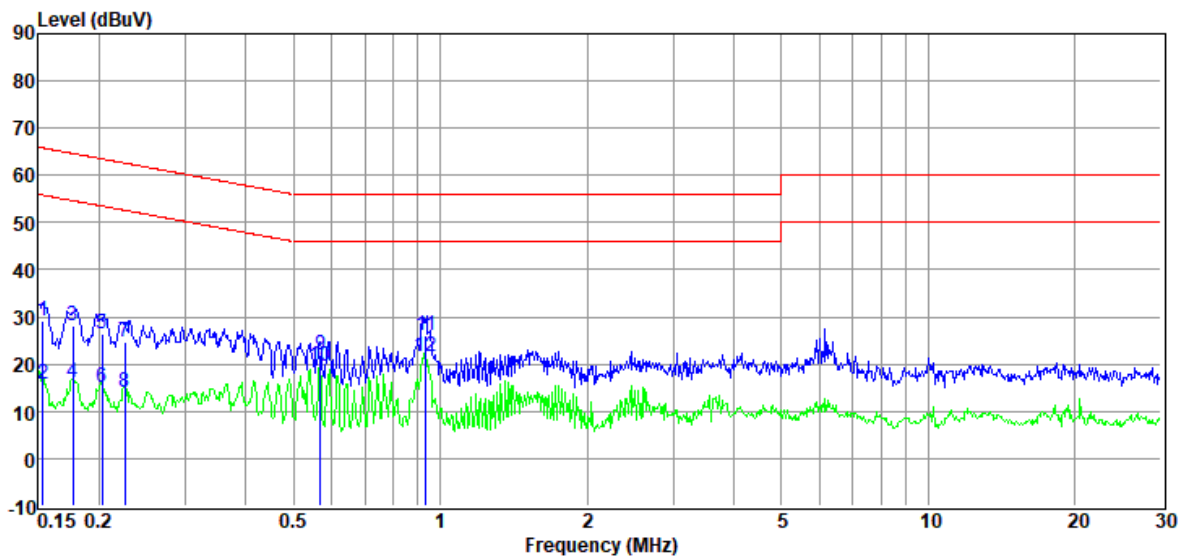

Item (Mark)	Freq. (MHz)	Read Level (dBμV)	LISN Factor (dB)	Cable Loss (dB)	Pulse Limiter Factor (dB)	Result Level (dBμV)	Limit Line (dBμV)	Margin (dB)	Detector	Phase
1	0.15	9.48	9.85	0.05	9.89	29.27	65.82	36.55	QP	LINE
2	0.15	-3.92	9.85	0.05	9.89	15.87	55.82	39.95	Average	LINE
3	0.18	8.30	9.84	0.06	9.89	28.09	64.64	36.55	QP	LINE
4	0.18	-3.55	9.84	0.06	9.89	16.24	54.64	38.40	Average	LINE
5	0.20	6.54	9.82	0.06	9.89	26.31	63.49	37.18	QP	LINE
6	0.20	-4.79	9.82	0.06	9.89	14.98	53.49	38.51	Average	LINE
7	0.23	4.99	9.82	0.06	9.89	24.76	62.61	37.85	QP	LINE
8	0.23	-5.85	9.82	0.06	9.89	13.92	52.61	38.69	Average	LINE
9	0.57	2.14	9.89	0.10	9.89	22.02	56.00	33.98	QP	LINE
10	0.57	-0.46	9.89	0.10	9.89	19.42	46.00	26.58	Average	LINE
11	0.93	6.26	9.89	0.14	9.90	26.19	56.00	29.81	QP	LINE
12	0.93	1.59	9.89	0.14	9.90	21.52	46.00	24.48	Average	LINE

Note:

1. Result Level = Read Level + LISN Factor + Pulse Limiter Factor + Cable loss.
2. If QP Result complies with AV limit, AV Result is deemed to comply with AV limit.
3. Test setup: RBW: 200 Hz (9 kHz—150 kHz), 9 kHz (150 kHz—30 MHz).
4. Step size: 80Hz (0.009MHz-0.15MHz), 4 kHz (0.15MHz-30MHz), Scan time: auto.

# TR-4-E-010 Conducted Emission Test Result

**Test Site** : DDT 1# Shield Room **D:\2025 CE report data\Q25091711-2E\0930 CE.EM6**  
**Test Date** : 2025-09-30 **Tested By** : Alex Liu  
**EUT** : PORTABLE BLUETOOTH SPEAKER **Model Number** : GO5D  
**Power Supply** : AC 120V/60Hz **Test Mode** : Charging + Bluetooth mode  
**Condition** : TEMP:22.3°C, RH:61.1% **LISN** : 2025 1# 216/NEUTRAL  
**Memo** : S25091711-003

Data: 12

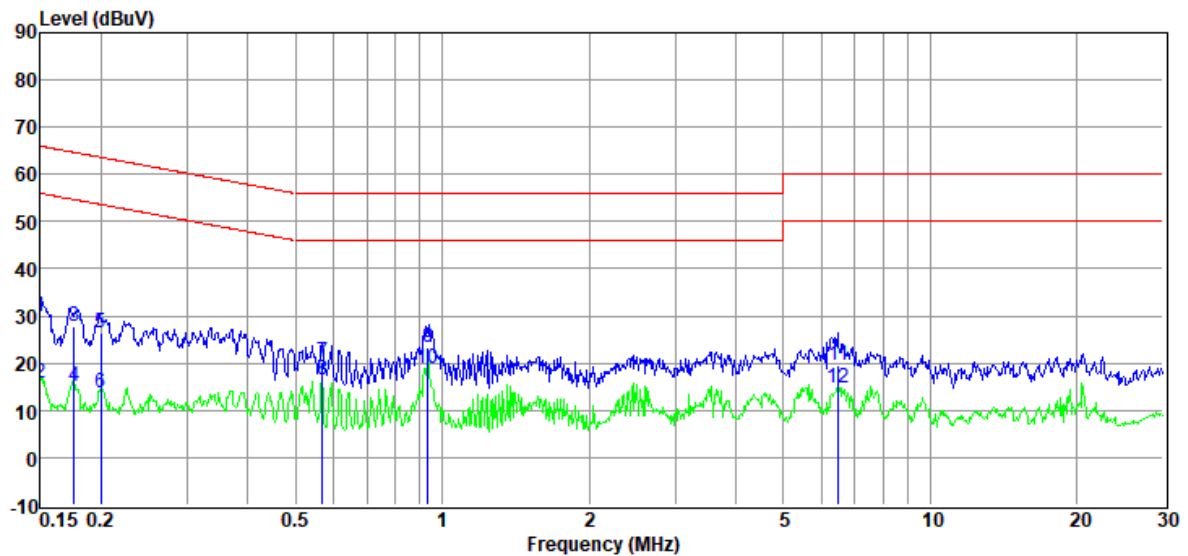

Item (Mark)	Freq. (MHz)	Read Level (dBμV)	LISN Factor (dB)	Cable Loss (dB)	Pulse Limiter Factor (dB)	Result Level (dBμV)	Limit Line (dBμV)	Margin (dB)	Detector	Phase
1	0.15	10.10	9.77	0.05	9.89	29.81	66.00	36.19	QP	NEUTRAL
2	0.15	-3.83	9.77	0.05	9.89	15.88	56.00	40.12	Average	NEUTRAL
3	0.18	8.19	9.71	0.06	9.89	27.85	64.68	36.83	QP	NEUTRAL
4	0.18	-4.54	9.71	0.06	9.89	15.12	54.68	39.56	Average	NEUTRAL
5	0.20	6.64	9.83	0.06	9.89	26.42	63.62	37.20	QP	NEUTRAL
6	0.20	-6.03	9.83	0.06	9.89	13.75	53.62	39.87	Average	NEUTRAL
7	0.57	0.51	9.89	0.10	9.89	20.39	56.00	35.61	QP	NEUTRAL
8	0.57	-3.31	9.89	0.10	9.89	16.57	46.00	29.43	Average	NEUTRAL
9	0.93	3.52	9.90	0.14	9.90	23.46	56.00	32.54	QP	NEUTRAL
10	0.93	-1.02	9.90	0.14	9.90	18.92	46.00	27.08	Average	NEUTRAL
11	6.49	-0.47	9.86	0.22	9.85	19.46	60.00	40.54	QP	NEUTRAL
12	6.49	-5.12	9.86	0.22	9.85	14.81	50.00	35.19	Average	NEUTRAL

Note:

1. Result Level = Read Level + LISN Factor + Pulse Limiter Factor + Cable loss.
2. If QP Result complies with AV limit, AV Result is deemed to comply with AV limit.
3. Test setup: RBW: 200 Hz (9 kHz—150 kHz), 9 kHz (150 kHz—30 MHz).
4. Step size: 80Hz (0.009MHz-0.15MHz), 4 kHz (0.15MHz-30MHz), Scan time: auto.

# TR-4-E-010 Conducted Emission Test Result

**Test Site** : DDT 1# Shield Room D:\2025 CE report data\Q25091711-2E\0930 CE.EM6  
**Test Date** : 2025-09-30 **Tested By** : Alex Liu  
**EUT** : PORTABLE BLUETOOTH SPEAKER **Model Number** : GO5D  
**Power Supply** : AC 240V/50Hz **Test Mode** : Charging + Bluetooth mode  
**Condition** : TEMP:22.3°C, RH:61.1% **LISN** : 2025 1# 216/NEUTRAL  
**Memo** : S25091711-003

Data: 14

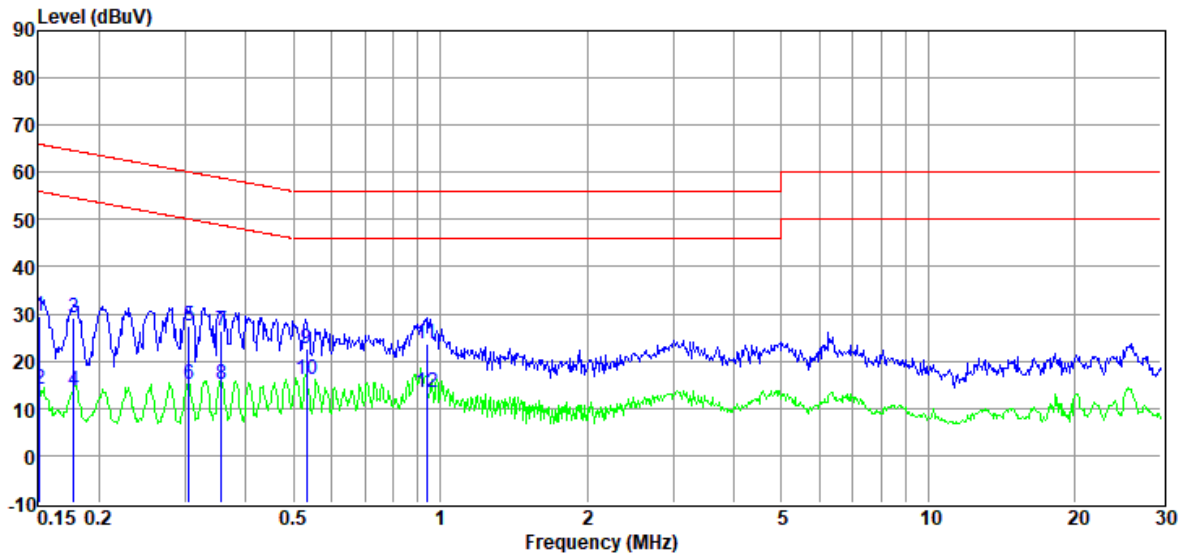

Item (Mark)	Freq. (MHz)	Read Level (dBuV)	LISN Factor (dB)	Cable Loss (dB)	Pulse Limiter Factor (dB)	Result Level (dBuV)	Limit Line (dBuV)	Margin (dB)	Detector	Phase
1	0.15	9.93	9.77	0.05	9.89	29.64	65.96	36.32	QP	NEUTRAL
2	0.15	-5.63	9.77	0.05	9.89	14.08	55.96	41.88	Average	NEUTRAL
3	0.18	9.50	9.72	0.06	9.89	29.17	64.59	35.42	QP	NEUTRAL
4	0.18	-6.08	9.72	0.06	9.89	13.59	54.59	41.00	Average	NEUTRAL
5	0.31	7.91	9.68	0.06	9.89	27.54	60.10	32.56	QP	NEUTRAL
6	0.31	-4.71	9.68	0.06	9.89	14.92	50.10	35.18	Average	NEUTRAL
7	0.36	6.44	9.91	0.07	9.89	26.31	58.83	32.52	QP	NEUTRAL
8	0.36	-4.85	9.91	0.07	9.89	15.02	48.83	33.81	Average	NEUTRAL
9	0.53	2.87	9.90	0.10	9.89	22.76	56.00	33.24	QP	NEUTRAL
10	0.53	-3.82	9.90	0.10	9.89	16.07	46.00	29.93	Average	NEUTRAL
11	0.94	3.59	9.90	0.14	9.90	23.53	56.00	32.47	QP	NEUTRAL
12	0.94	-6.71	9.90	0.14	9.90	13.23	46.00	32.77	Average	NEUTRAL

Note:

1. Result Level = Read Level + LISN Factor + Pulse Limiter Factor + Cable loss.
2. If QP Result complies with AV limit, AV Result is deemed to comply with AV limit.
3. Test setup: RBW: 200 Hz (9 kHz—150 kHz), 9 kHz (150 kHz—30 MHz).
4. Step size: 80Hz (0.009MHz-0.15MHz), 4 kHz (0.15MHz-30MHz), Scan time: auto.

# TR-4-E-010 Conducted Emission Test Result

**Test Site** : DDT 1# Shield Room D:\2025 CE report data\Q25091711-2E\0930 CE.EM6  
**Test Date** : 2025-09-30 **Tested By** : Alex Liu  
**EUT** : PORTABLE BLUETOOTH SPEAKER **Model Number** : GO5D  
**Power Supply** : AC 240V/50Hz **Test Mode** : Charging + Bluetooth mode  
**Condition** : TEMP:22.3°C, RH:61.1% **LISN** : 2025 1# 216/LINE  
**Memo** : S25091711-003

Data: 16

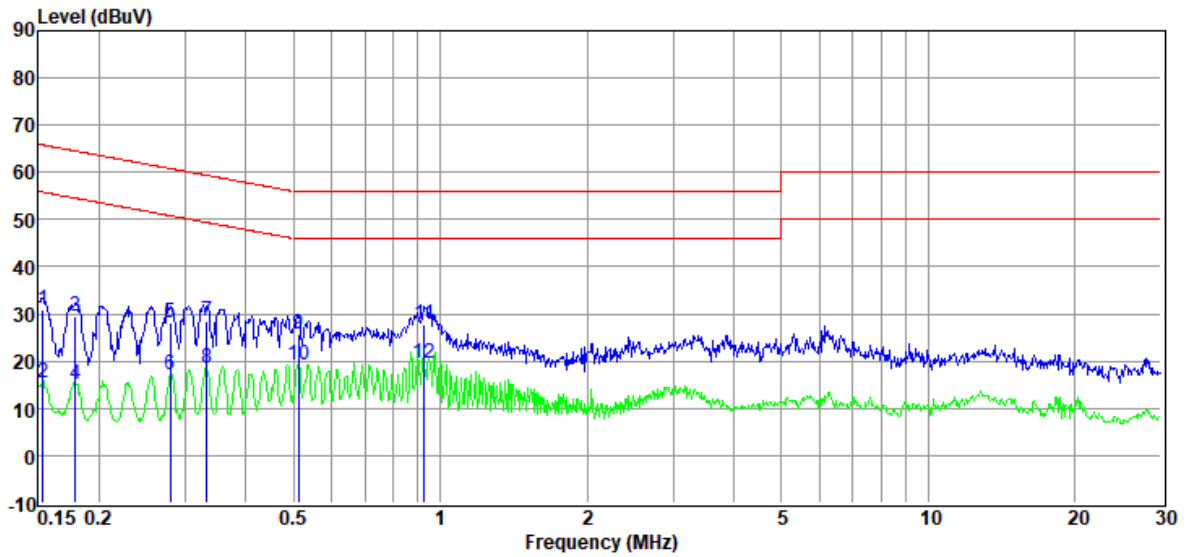

Item (Mark)	Freq. (MHz)	Read Level (dBuV)	LISN Factor (dB)	Cable Loss (dB)	Pulse Limiter Factor (dB)	Result Level (dBuV)	Limit Line (dBuV)	Margin (dB)	Detector	Phase
1	0.15	11.02	9.85	0.05	9.89	30.81	65.82	35.01	QP	LINE
2	0.15	-4.23	9.85	0.05	9.89	15.56	55.82	40.26	Average	LINE
3	0.18	9.86	9.83	0.06	9.89	29.64	64.55	34.91	QP	LINE
4	0.18	-4.58	9.83	0.06	9.89	15.20	54.55	39.35	Average	LINE
5	0.28	8.57	9.74	0.06	9.89	28.26	60.81	32.55	QP	LINE
6	0.28	-2.39	9.74	0.06	9.89	17.30	50.81	33.51	Average	LINE
7	0.33	8.92	9.67	0.07	9.89	28.55	59.40	30.85	QP	LINE
8	0.33	-1.05	9.67	0.07	9.89	18.58	49.40	30.82	Average	LINE
9	0.51	5.82	9.79	0.09	9.89	25.59	56.00	30.41	QP	LINE
10	0.51	-0.69	9.79	0.09	9.89	19.08	46.00	26.92	Average	LINE
11	0.93	7.71	9.89	0.14	9.90	27.64	56.00	28.36	QP	LINE
12	0.93	-0.41	9.89	0.14	9.90	19.52	46.00	26.48	Average	LINE

**Note:**

1. Result Level = Read Level + LISN Factor + Pulse Limiter Factor + Cable loss.
2. If QP Result complies with AV limit, AV Result is deemed to comply with AV limit.
3. Test setup: RBW: 200 Hz (9 kHz—150 kHz), 9 kHz (150 kHz—30 MHz).
4. Step size: 80Hz (0.009MHz-0.15MHz), 4 kHz (0.15MHz-30MHz), Scan time: auto.

# TR-4-E-010 Conducted Emission Test Result

**Test Site** : DDT 1# Shield Room **D:\2025 CE report data\Q25091711-2E\0930 CE.EM6**  
**Test Date** : 2025-09-30 **Tested By** : Alex Liu  
**EUT** : PORTABLE BLUETOOTH SPEAKER **Model Number** : GO5D  
**Power Supply** : AC 240V/50Hz **Test Mode** : Charging + Bluetooth + TWS mode  
**Condition** : TEMP:22.3°C, RH:61.1% **LISN** : 2025 1# 216/LINE  
**Memo** : S25091711-003

Data: 18

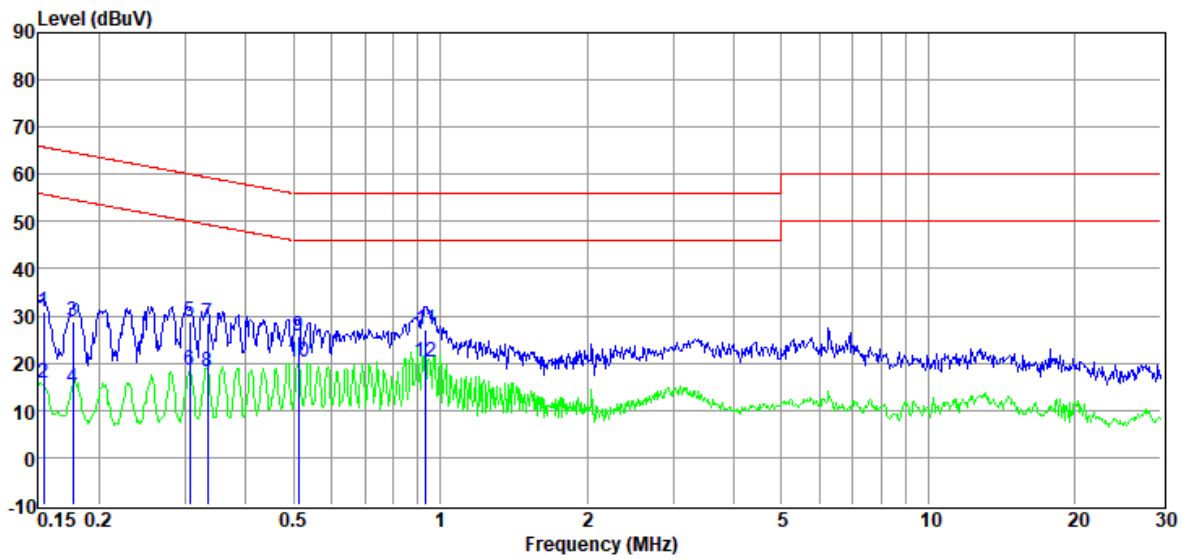

Item (Mark)	Freq. (MHz)	Read Level (dBuV)	LISN Factor (dB)	Cable Loss (dB)	Pulse Limiter Factor (dB)	Result Level (dBuV)	Limit Line (dBuV)	Margin (dB)	Detector	Phase
1	0.15	11.05	9.85	0.05	9.89	30.84	65.78	34.94	QP	LINE
2	0.15	-4.08	9.85	0.05	9.89	15.71	55.78	40.07	Average	LINE
3	0.18	9.04	9.84	0.06	9.89	28.83	64.64	35.81	QP	LINE
4	0.18	-5.13	9.84	0.06	9.89	14.66	54.64	39.98	Average	LINE
5	0.31	9.33	9.69	0.06	9.89	28.97	60.06	31.09	QP	LINE
6	0.31	-1.08	9.69	0.06	9.89	18.56	50.06	31.50	Average	LINE
7	0.33	8.88	9.67	0.07	9.89	28.51	59.35	30.84	QP	LINE
8	0.33	-1.51	9.67	0.07	9.89	18.12	49.35	31.23	Average	LINE
9	0.51	5.96	9.79	0.09	9.89	25.73	56.00	30.27	QP	LINE
10	0.51	0.36	9.79	0.09	9.89	20.13	46.00	25.87	Average	LINE
11	0.93	7.03	9.89	0.14	9.90	26.96	56.00	29.04	QP	LINE
12	0.93	0.20	9.89	0.14	9.90	20.13	46.00	25.87	Average	LINE

Note:

1. Result Level = Read Level + LISN Factor + Pulse Limiter Factor + Cable loss.
2. If QP Result complies with AV limit, AV Result is deemed to comply with AV limit.
3. Test setup: RBW: 200 Hz (9 kHz—150 kHz), 9 kHz (150 kHz—30 MHz).
4. Step size: 80Hz (0.009MHz-0.15MHz), 4 kHz (0.15MHz-30MHz), Scan time: auto.

# TR-4-E-010 Conducted Emission Test Result

**Test Site** : DDT 1# Shield Room D:\2025 CE report data\Q25091711-2E\0930 CE.EM6  
**Test Date** : 2025-09-30 **Tested By** : Alex Liu  
**EUT** : PORTABLE BLUETOOTH SPEAKER **Model Number** : GO5D  
**Power Supply** : AC 240V/50Hz **Test Mode** : Charging + Bluetooth + TWS mode  
**Condition** : TEMP:22.3°C, RH:61.1% **LISN** : 2025 1# 216/NEUTRAL  
**Memo** : S25091711-003

Data: 20

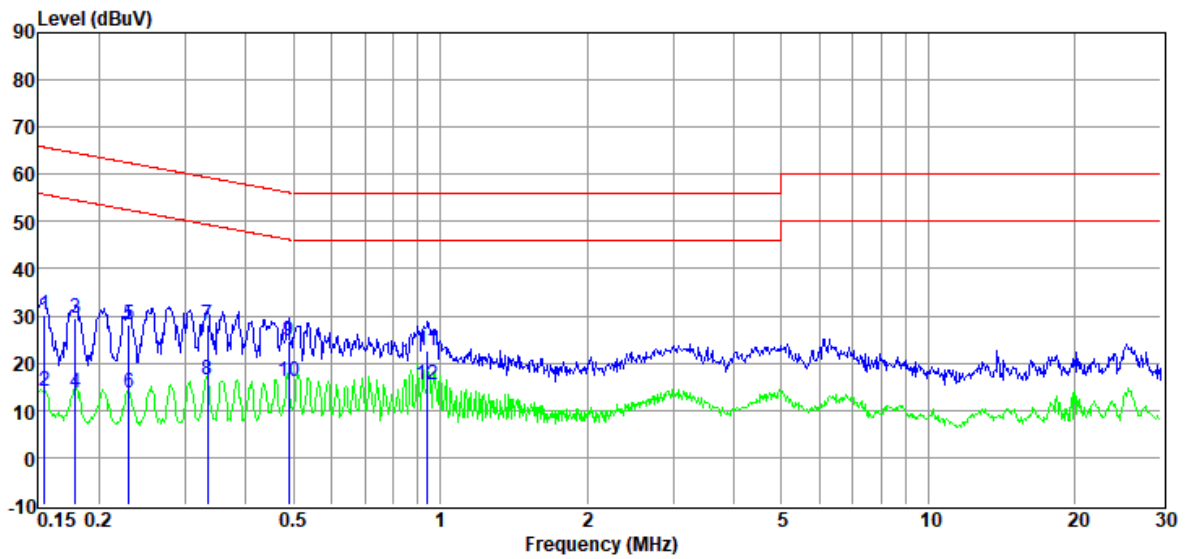

Item (Mark)	Freq. (MHz)	Read Level (dBμV)	LISN Factor (dB)	Cable Loss (dB)	Pulse Limiter Factor (dB)	Result Level (dBμV)	Limit Line (dBμV)	Margin (dB)	Detector	Phase
1	0.15	10.35	9.75	0.05	9.89	30.04	65.74	35.70	QP	NEUTRAL
2	0.15	-5.79	9.75	0.05	9.89	13.90	55.74	41.84	Average	NEUTRAL
3	0.18	9.71	9.73	0.06	9.89	29.39	64.55	35.16	QP	NEUTRAL
4	0.18	-5.90	9.73	0.06	9.89	13.78	54.55	40.77	Average	NEUTRAL
5	0.23	8.28	9.84	0.06	9.89	28.07	62.44	34.37	QP	NEUTRAL
6	0.23	-5.99	9.84	0.06	9.89	13.80	52.44	38.64	Average	NEUTRAL
7	0.33	8.44	9.84	0.07	9.89	28.24	59.35	31.11	QP	NEUTRAL
8	0.33	-3.33	9.84	0.07	9.89	16.47	49.35	32.88	Average	NEUTRAL
9	0.49	4.69	9.90	0.09	9.89	24.57	56.19	31.62	QP	NEUTRAL
10	0.49	-3.64	9.90	0.09	9.89	16.24	46.19	29.95	Average	NEUTRAL
11	0.94	2.73	9.90	0.14	9.90	22.67	56.00	33.33	QP	NEUTRAL
12	0.94	-4.63	9.90	0.14	9.90	15.31	46.00	30.69	Average	NEUTRAL

Note:

1. Result Level = Read Level + LISN Factor + Pulse Limiter Factor + Cable loss.
2. If QP Result complies with AV limit, AV Result is deemed to comply with AV limit.
3. Test setup: RBW: 200 Hz (9 kHz—150 kHz), 9 kHz (150 kHz—30 MHz).
4. Step size: 80Hz (0.009MHz-0.15MHz), 4 kHz (0.15MHz-30MHz), Scan time: auto.

# TR-4-E-010 Conducted Emission Test Result

**Test Site** : DDT 1# Shield Room **D:\2025 CE report data\Q25091711-2E\0930 CE.EM6**  
**Test Date** : 2025-09-30 **Tested By** : Alex Liu  
**EUT** : PORTABLE BLUETOOTH SPEAKER **Model Number** : GO5D  
**Power Supply** : AC 120V/60Hz **Test Mode** : Charging + Bluetooth + TWS mode  
**Condition** : TEMP:22.3°C, RH:61.1% **LISN** : 2025 1# 216/NEUTRAL  
**Memo** : S25091711-003

Data: 22

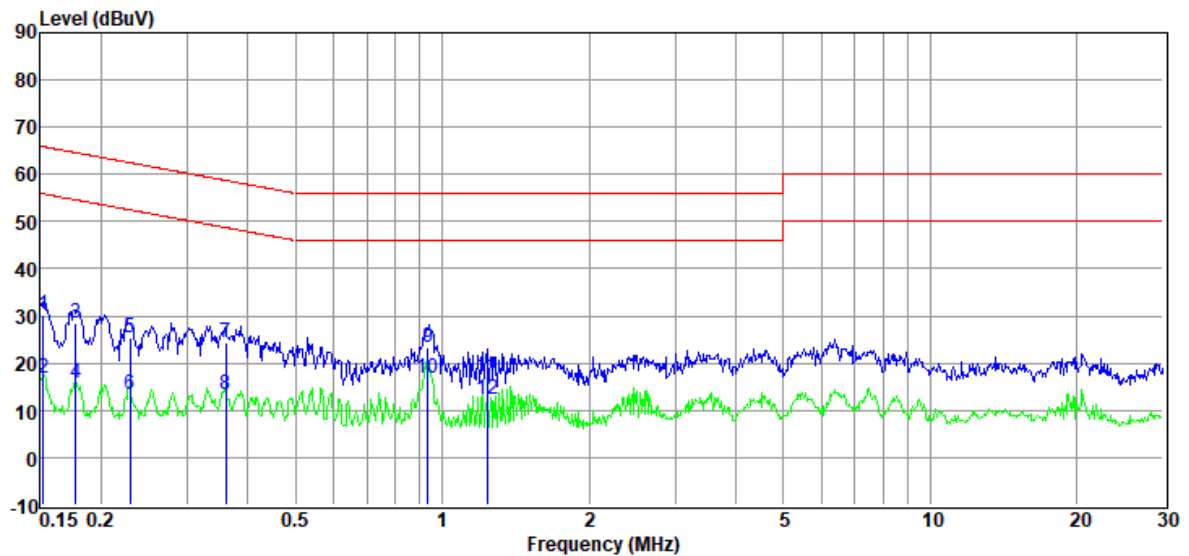

Item (Mark)	Freq. (MHz)	Read Level (dBμV)	LISN Factor (dB)	Cable Loss (dB)	Pulse Limiter Factor (dB)	Result Level (dBμV)	Limit Line (dBμV)	Margin (dB)	Detector	Phase
1	0.15	10.56	9.76	0.05	9.89	30.26	65.87	35.61	QP	NEUTRAL
2	0.15	-3.04	9.76	0.05	9.89	16.66	55.87	39.21	Average	NEUTRAL
3	0.18	8.68	9.72	0.06	9.89	28.35	64.59	36.24	QP	NEUTRAL
4	0.18	-3.92	9.72	0.06	9.89	15.75	54.59	38.84	Average	NEUTRAL
5	0.23	5.69	9.84	0.06	9.89	25.48	62.48	37.00	QP	NEUTRAL
6	0.23	-6.45	9.84	0.06	9.89	13.34	52.48	39.14	Average	NEUTRAL
7	0.36	4.49	9.90	0.07	9.89	24.35	58.74	34.39	QP	NEUTRAL
8	0.36	-6.48	9.90	0.07	9.89	13.38	48.74	35.36	Average	NEUTRAL
9	0.93	3.25	9.90	0.14	9.90	23.19	56.00	32.81	QP	NEUTRAL
10	0.93	-3.08	9.90	0.14	9.90	16.86	46.00	29.14	Average	NEUTRAL
11	1.24	-2.88	9.89	0.16	9.90	17.07	56.00	38.93	QP	NEUTRAL
12	1.24	-7.64	9.89	0.16	9.90	12.31	46.00	33.69	Average	NEUTRAL

## Note:

1. Result Level = Read Level + LISN Factor + Pulse Limiter Factor + Cable loss.
2. If QP Result complies with AV limit, AV Result is deemed to comply with AV limit.
3. Test setup: RBW: 200 Hz (9 kHz—150 kHz), 9 kHz (150 kHz—30 MHz).
4. Step size: 80Hz (0.009MHz-0.15MHz), 4 kHz (0.15MHz-30MHz), Scan time: auto.

# TR-4-E-010 Conducted Emission Test Result

**Test Site** : DDT 1# Shield Room **D:\2025 CE report data\Q25091711-2E\0930 CE.EM6**  
**Test Date** : 2025-09-30 **Tested By** : Alex Liu  
**EUT** : PORTABLE BLUETOOTH SPEAKER **Model Number** : GO5D  
**Power Supply** : AC 120V/60Hz **Test Mode** : Charging + Bluetooth + TWS mode  
**Condition** : TEMP:22.3°C, RH:61.1% **LISN** : 2025 1# 216/LINE  
**Memo** : S25091711-003

Data: 24

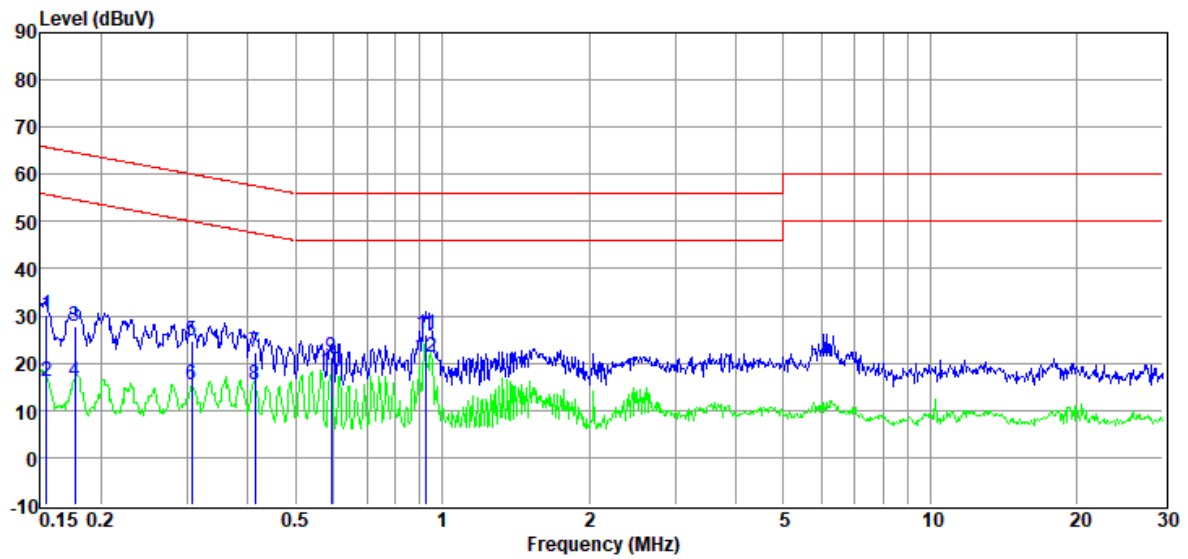

Item (Mark)	Freq. (MHz)	Read Level (dBμV)	LISN Factor (dB)	Cable Loss (dB)	Pulse Limiter Factor (dB)	Result Level (dBμV)	Limit Line (dBμV)	Margin (dB)	Detector	Phase
1	0.15	10.47	9.85	0.05	9.89	30.26	65.74	35.48	QP	LINE
2	0.15	-3.67	9.85	0.05	9.89	16.12	55.74	39.62	Average	LINE
3	0.18	8.08	9.84	0.06	9.89	27.87	64.64	36.77	QP	LINE
4	0.18	-3.78	9.84	0.06	9.89	16.01	54.64	38.63	Average	LINE
5	0.31	5.22	9.69	0.06	9.89	24.86	60.06	35.20	QP	LINE
6	0.31	-4.18	9.69	0.06	9.89	15.46	50.06	34.60	Average	LINE
7	0.41	2.50	9.70	0.08	9.89	22.17	57.59	35.42	QP	LINE
8	0.41	-4.26	9.70	0.08	9.89	15.41	47.59	32.18	Average	LINE
9	0.59	1.18	9.93	0.10	9.89	21.10	56.00	34.90	QP	LINE
10	0.59	-1.75	9.93	0.10	9.89	18.17	46.00	27.83	Average	LINE
11	0.93	6.16	9.89	0.14	9.90	26.09	56.00	29.91	QP	LINE
12	0.93	1.27	9.89	0.14	9.90	21.20	46.00	24.80	Average	LINE

Note:

1. Result Level = Read Level + LISN Factor + Pulse Limiter Factor + Cable loss.
2. If QP Result complies with AV limit, AV Result is deemed to comply with AV limit.
3. Test setup: RBW: 200 Hz (9 kHz—150 kHz), 9 kHz (150 kHz—30 MHz).
4. Step size: 80Hz (0.009MHz-0.15MHz), 4 kHz (0.15MHz-30MHz), Scan time: auto.

### 3.8. Test photo

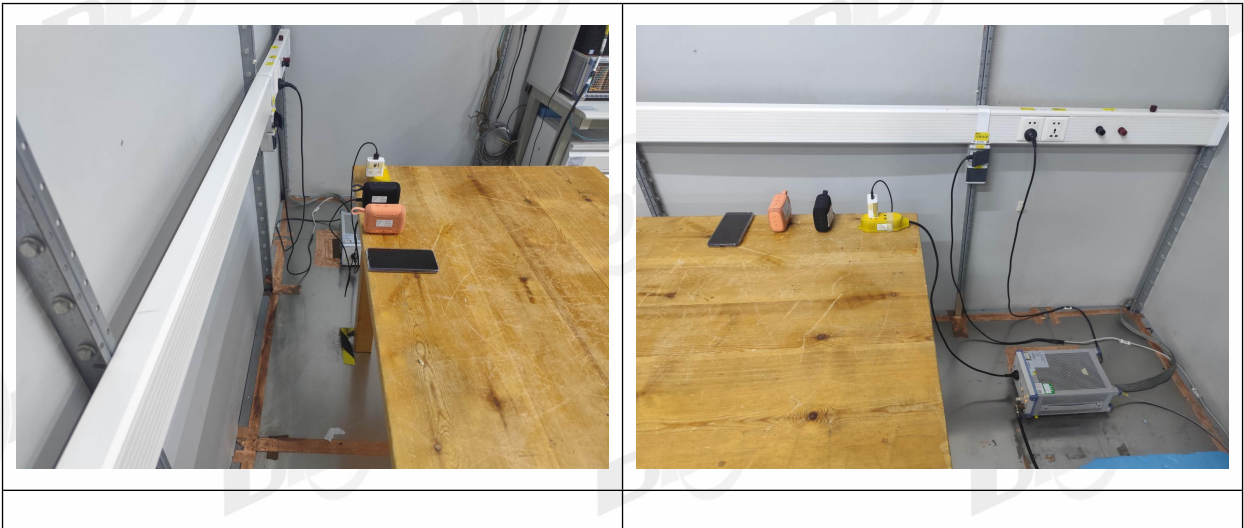

## 4. Radiated Emissions Test

### 4.1. Test equipment

Equipment	Manufacturer	Model No.	Equipment No.	Cal Due To
Pre-amplifier	SONOMA	310N	DDT-ZC00534	2026/07/06
Pre-amplifier	SONOMA	310N	DDT-ZC01970	2026/07/06
EMI Test Receiver	R&S	ESCI7	DDT-ZC01819	2026/03/28
EMI Test Receiver	R&S	ESCI 3	DDT-ZC01971	2026/03/28
Trilog Broadband Antenna	Schwarzbeck	VULB 9163	DDT-ZC02048	2026/07/22
Trilog Broadband Antenna	Schwarzbeck	VULB 9163	DDT-ZC02049	2026/07/11
PSA Series Spectrum Analyzer	Agilent	E4447A	DDT-ZC00517	2026/03/28
RF cable	DDT	H0.5M+1M+3M+(6M+4M)	DDT-ZC02533	2026/08/10
RF cable	DDT	V0.5M+1M+3M+(11M+6M)	DDT-ZC02534	2026/08/10
Preamplifier	COM-POWER	PAM-118A	DDT-ZC01489	2026/08/10
Hochgewinn-Hornantenne	SCHWARZBECK	BBHA 9120 D	DDT-ZC02129	2026/08/11
Radiation disturbance fully automated test software	Tonscend	JS32-RE	DDT-ZC02644	/
Active Loop Antenna	Schwarzbeck	FMZB1519	DDT-ZC00524	2026/08/18
Spectrum Analyzer	Agilent	E4440A	DDT-ZC01445	2026/03/28
Broad-Band Horn Antenna	Schwarzbeck	BBHA 9170	DDT-ZC00506	2026/04/01
Horn Antenna	SCHWARZBECK	BBHA9120 D	DDT-ZC01218	2026/08/13
Preamplifier	COM-POWER	PAM-118A	DDT-ZC01489	2026/08/10
Pre-amplifier	COM-POWER	PAM-840A	DDT-ZC01693	2026/03/28
EMI Test Software	Audix/TW	e3	DDT-ZC01252	/
RF cable	Zhongke Junchuang	JCTB810-NJ-NJ-7M	DDT-ZC02759	2026/07/22

### 4.2. Block diagram of test setup

Below 1 GHz

For table-top equipment

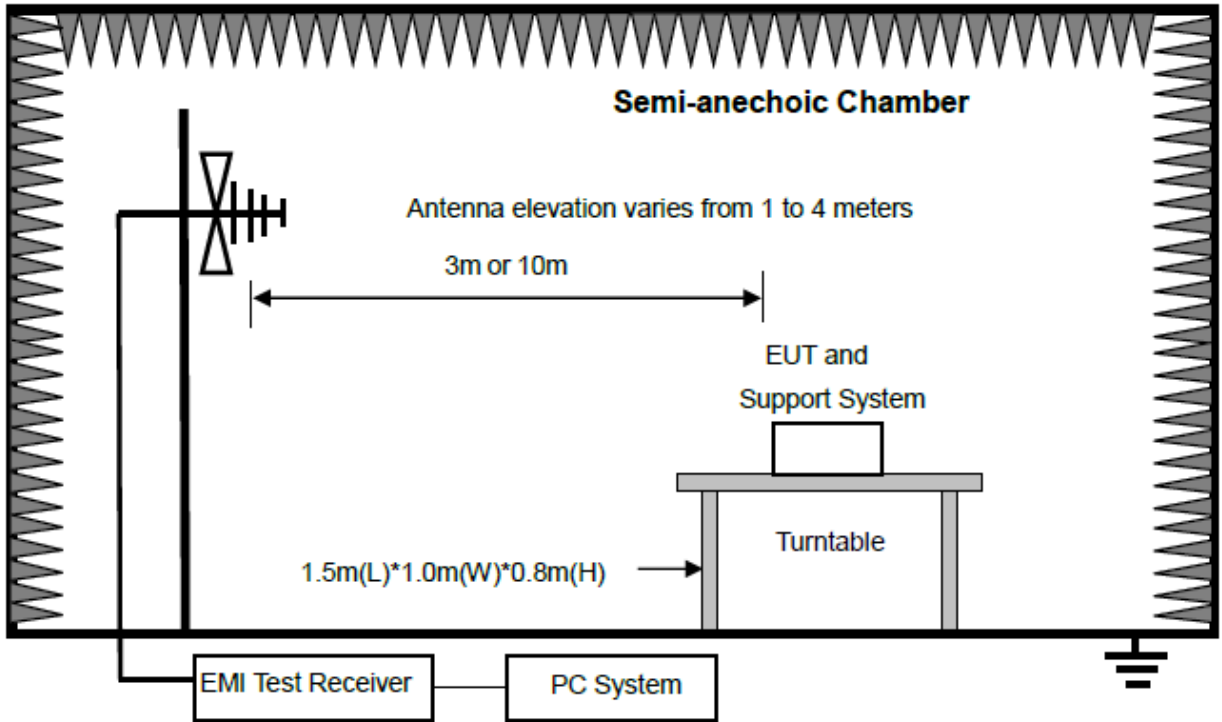

For floor standing equipment

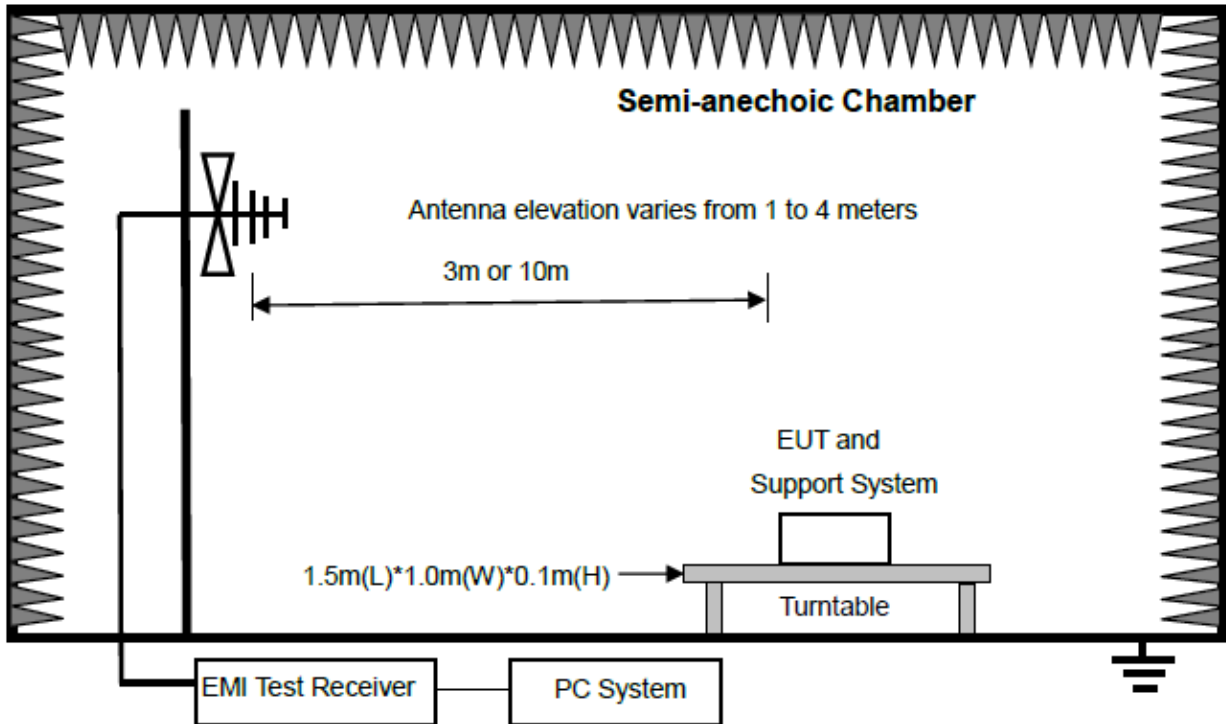

For combinations equipment

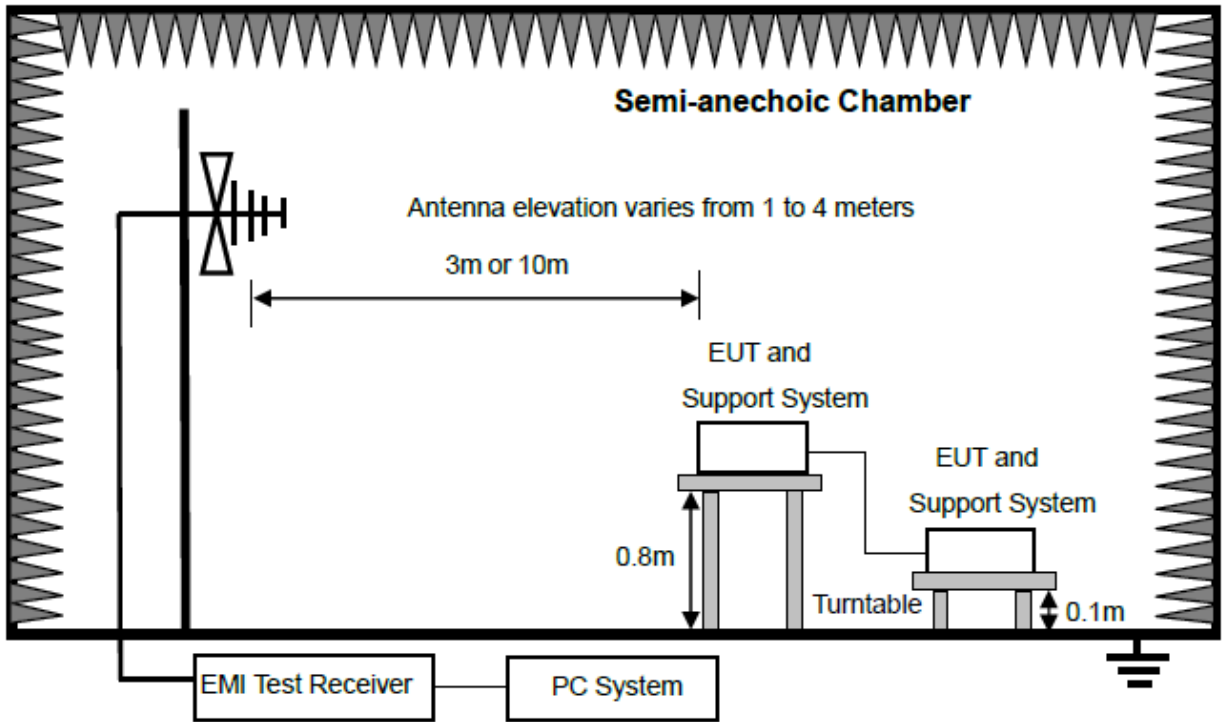

Above 1 GHz

For table-top equipment

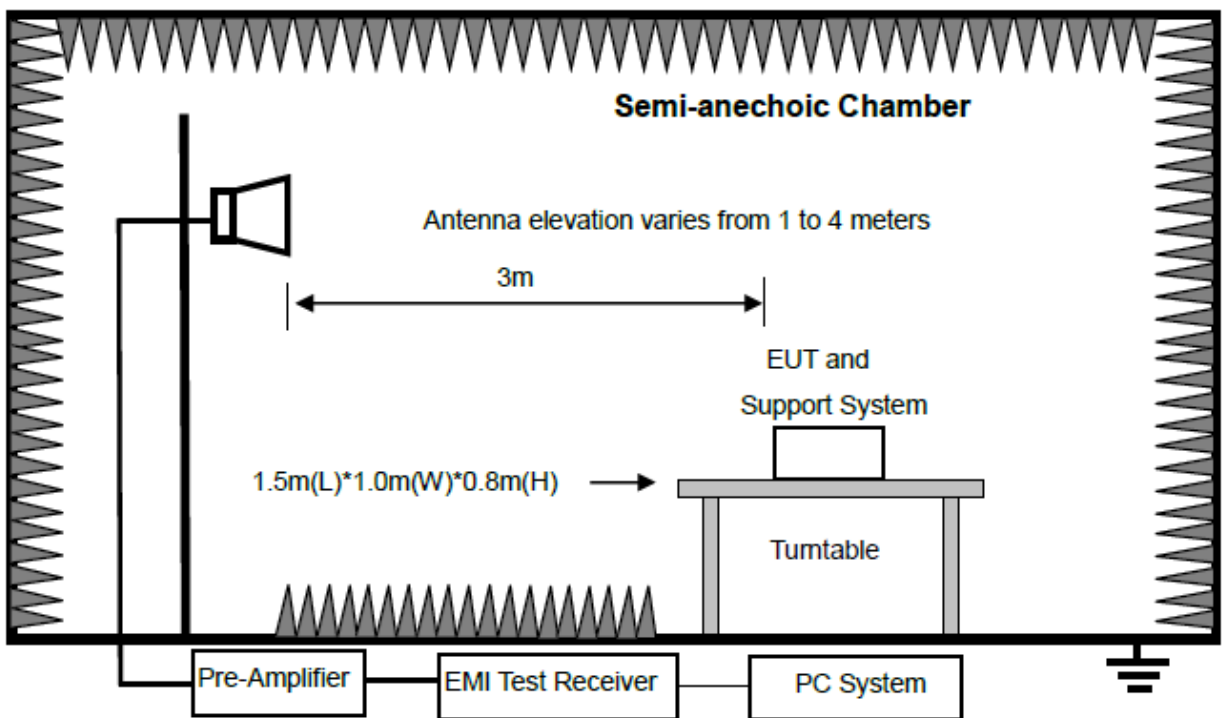

For floor standing equipment

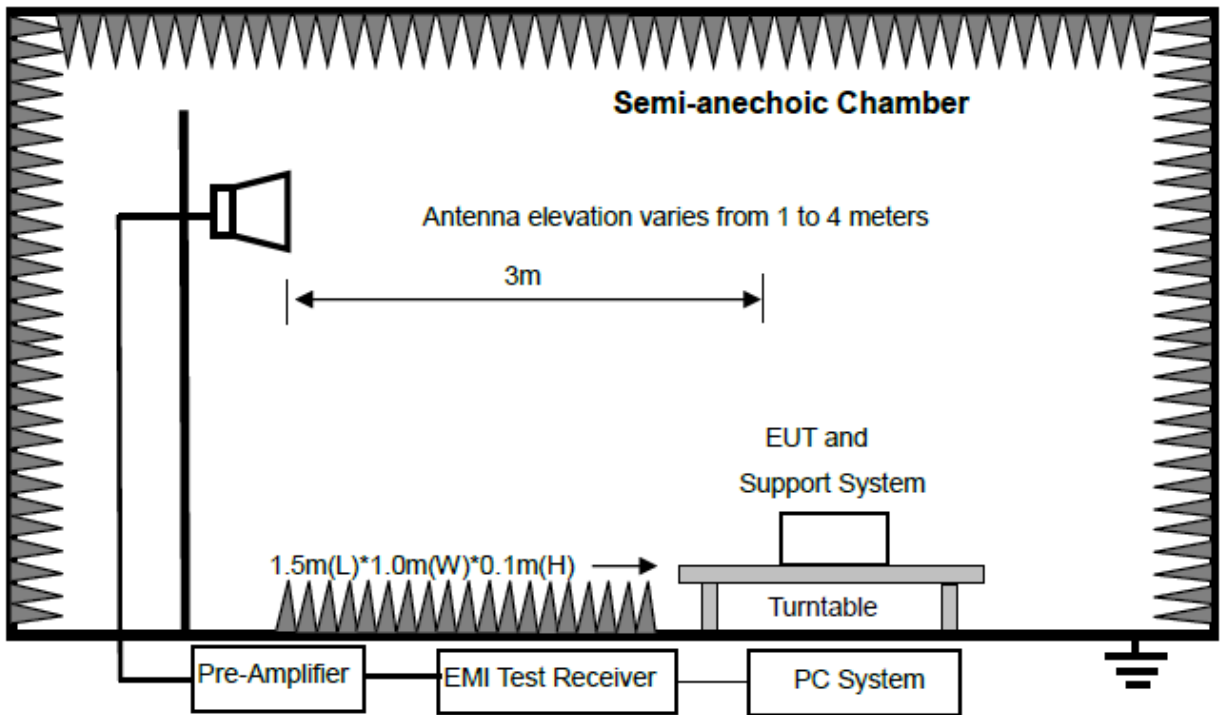

For combinations equipment

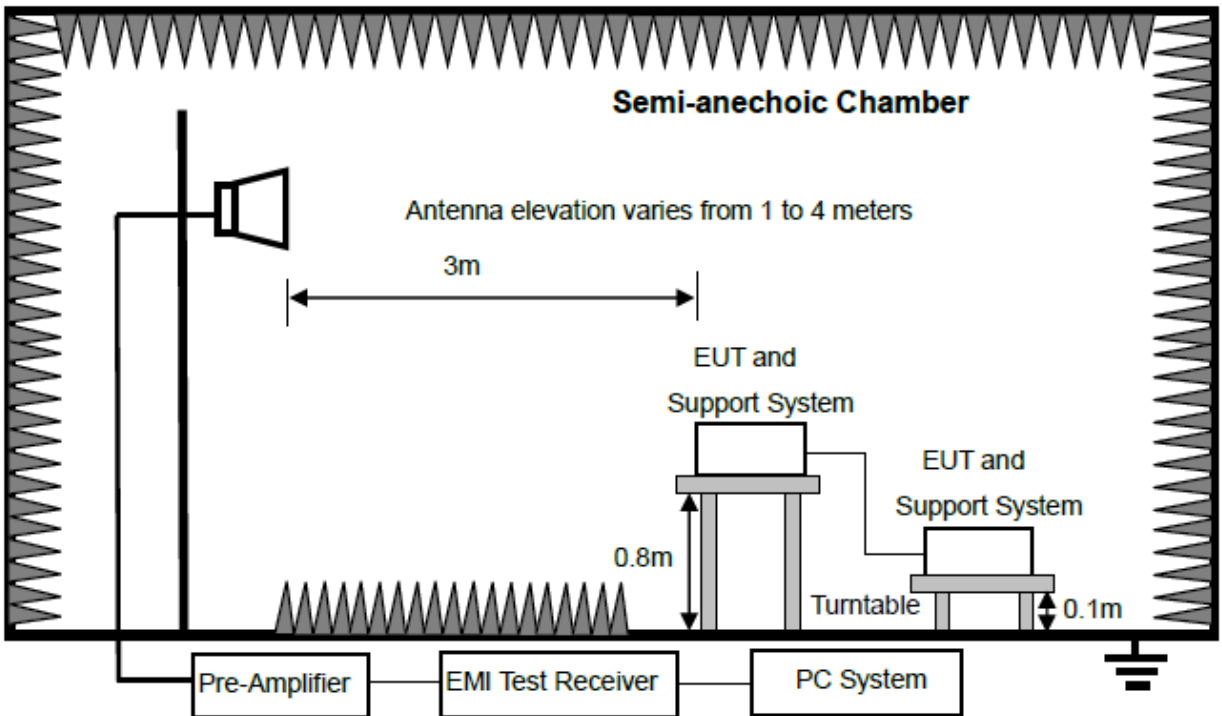

### 4.3. Limits

Equipment	Frequency	Field Strengths Limits at 10m measuring distance dB( $\mu$ V)/m	Field Strengths Limits at 3m measuring distance dB( $\mu$ V)/m
Class A Equipment	30 MHz to 230 MHz	40	50
	230 MHz to 1000 MHz	47	57
	1 GHz to 3 GHz	/	Average:56; Peak:76
	3 GHz to 6 GHz	/	Average:60; Peak:80
Equipment	Frequency	Field Strengths Limits at 10m measuring distance dB( $\mu$ V)/m	Field Strengths Limits at 3m measuring distance dB( $\mu$ V)/m
Class B Equipment	30 MHz to 230 MHz	30	40
	230 MHz to 1000 MHz	37	47
	1 GHz to 3 GHz	/	Average:50; Peak:70
	3 GHz to 6 GHz	/	Average:54; Peak:74

Note:

(1) The smaller limit shall apply at the cross point between two frequency bands.

(2) Distance is the distance in meters between the measuring instrument, antenna and the closest point of any part of the device or system.

### 4.4. Assistant equipment used for test

Assistant equipment	Manufacturer	Model number	Description	other
Phone	HUAWEI	MATE 20	N/A	N/A
Adapter	HUAWEI	HW110600C02	N/A	N/A
PORTABLE BLUETOOTH SPEAKER	Harman	GO5D	N/A	N/A
USB cable	N/A	N/A	Length: 1m	N/A
Laptop	HP	Omni Book 7	N/A	N/A
Phone	Apple	iPhone 15	N/A	N/A

### 4.5. Test procedure

(1) The EUT was placed on a non-metallic table (Refer to the 'Block diagram of test setup'). above the ground plane inside an anechoic chamber.

(2) Test antenna was located 3m or 10m (see note) from the EUT on an adjustable mast. A pre-scan was first performed in order to find prominent radiated emissions. For final emissions measurements at each frequency of interest, the EUT were rotated and the antenna height was varied between 1m and 4m in order to maximize the emission. Measurements in both horizontal and vertical polarities were made and the data was recorded. In order to find the maximum emission, the relative positions of equipment and all of the interface cables were changed according to ETSI EN 301 489 on radiated emission test.

(3) Spectrum frequency from 30 MHz to  $\square$ 1 GHz / $\square$ 6 GHz was investigated.

(4) For final emissions measurements at each frequency of interest, the EUT were rotated and the antenna height was varied between 1m and 4m in order to maximize the emission. Measurements in both horizontal and vertical polarities were made and the data was recorded. In order to find the maximum emission, the relative positions of equipment and all of the interface cables were changed according to ETSI EN 301 489 on Radiated Emission test.

(5) For emissions from 30 MHz to 1GHz, Quasi-Peak values were measured with EMI Receiver and the bandwidth of Receiver is 120 kHz.

(6) For emissions above 1 GHz, both Peak and Average level were measured with Spectrum Analyzer, and the RBW is set at 1 MHz VBW is set at 3 MHz.

#### 4.6. Test result

**Pass.** (See below detailed test result)

Note 1: All emissions not reported below are too low against the prescribed limits.

Note 2: "-----" means Peak detection.

## 4.7. Test data

## TR-4-E-009 Radiated Emission Test Result

**Test Date:** 2025-10-15      **Tested By:** Mende Guo  
**EUT:** PORTABLE BLUETOOTH SPEAKER      **Model Number:** GO5D  
**Test Mode:** Charging + Bluetooth mode      **Power Supply:** AC 120V/60Hz  
**Condition:** Temp:22.8°C;Humi:54.2%      **Test Site:** DDT 10M Chamber  
**File Path:** d:\ts\2025 report data\Q25091711-2E\1015 10M RE\21  
**Memo:** S25091711-003

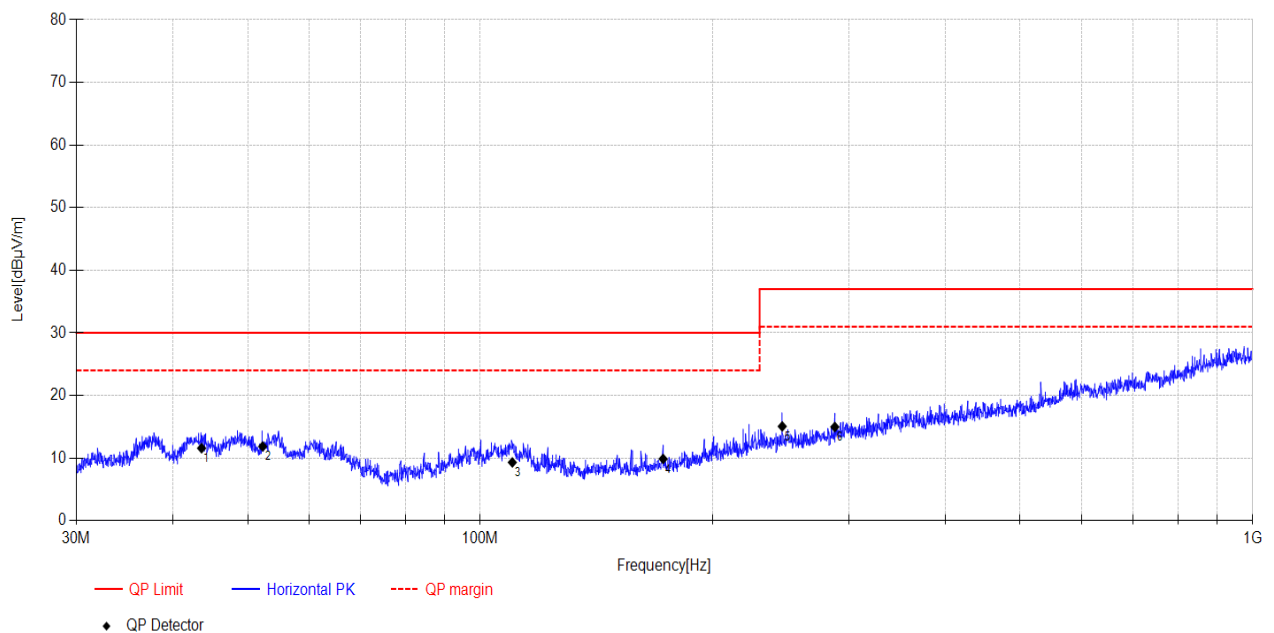

Final Data List								
NO.	Freq. [MHz]	Reading [dBμV]	Factor [dB]	Result [dBμV/m]	Limit [dBμV/m]	Margin [dB]	Detector	Polarity
1	43.58	27.12	-15.54	11.58	30.00	18.42	QP	Horizontal
2	52.29	27.13	-15.27	11.86	30.00	18.14	QP	Horizontal
3	110.05	25.64	-16.33	9.31	30.00	20.69	QP	Horizontal
4	172.52	28.29	-18.42	9.87	30.00	20.13	QP	Horizontal
5	246.04	30.05	-14.99	15.06	37.00	21.94	QP	Horizontal
6	287.83	29.07	-14.10	14.97	37.00	22.03	QP	Horizontal

Note: 1. Result Level = Reading + Factor.

2. If Peak Result complies with QP limit, QP Result is deemed to comply with QP limit.

3. Test setup: RBW: 120 kHz, VBW: 300 kHz, Sweep time: auto.

# TR-4-E-009 Radiated Emission Test Result

**Test Date:** 2025-10-15      **Tested By:** Mende Guo  
**EUT:** PORTABLE BLUETOOTH SPEAKER      **Model Number:** GO5D  
**Test Mode:** Charging + Bluetooth mode      **Power Supply:** AC 120V/60Hz  
**Condition:** Temp:22.8°C;Humi:54.2%      **Test Site:** DDT 10M Chamber  
**File Path:** d:\ts\2025 report data\Q25091711-2E\1015 10M RE\22  
**Memo:** S25091711-003

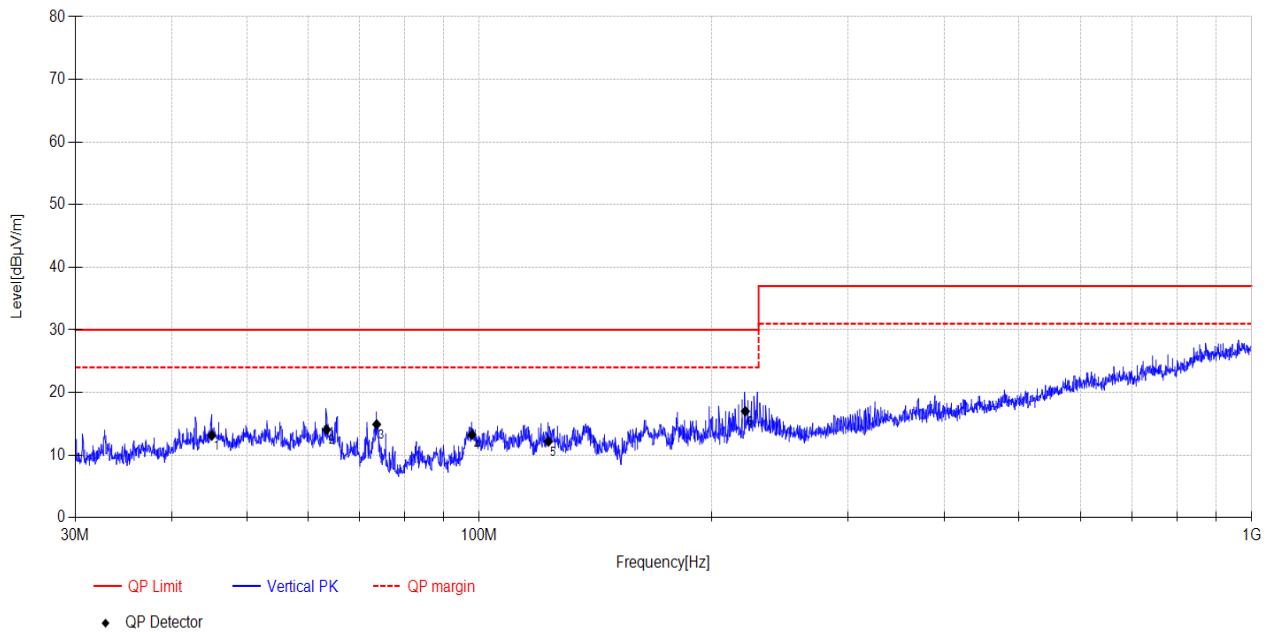

Final Data List								
NO.	Freq. [MHz]	Reading [dBµV]	Factor [dB]	Result [dBµV/m]	Limit [dBµV/m]	Margin [dB]	Detector	Polarity
1	45.05	27.6	-14.49	13.11	30.00	16.89	QP	Vertical
2	63.47	29.95	-15.88	14.07	30.00	15.93	QP	Vertical
3	73.67	34.03	-19.13	14.90	30.00	15.10	QP	Vertical
4	97.86	29.36	-16.11	13.25	30.00	16.75	QP	Vertical
5	122.90	30.16	-17.99	12.17	30.00	17.83	QP	Vertical
6	221.09	32.32	-15.32	17.00	30.00	13.00	QP	Vertical

Note: 1. Result Level = Reading + Factor.  
 2. If Peak Result complies with QP limit, QP Result is deemed to comply with QP limit.  
 3. Test setup: RBW: 120 kHz, VBW: 300 kHz, Sweep time: auto.

# TR-4-E-009 Radiated Emission Test Result

**Test Date:** 2025-10-15      **Tested By:** Mende Guo  
**EUT:** PORTABLE BLUETOOTH SPEAKER      **Model Number:** GO5D  
**Test Mode:** Charging + Bluetooth mode      **Power Supply:** AC 240V/50Hz  
**Condition:** Temp:22.8°C;Humi:54.2%      **Test Site:** DDT 10M Chamber  
**File Path:** d:\ts\2025 report data\Q25091711-2E\1015 10M RE\23  
**Memo:** S25091711-003

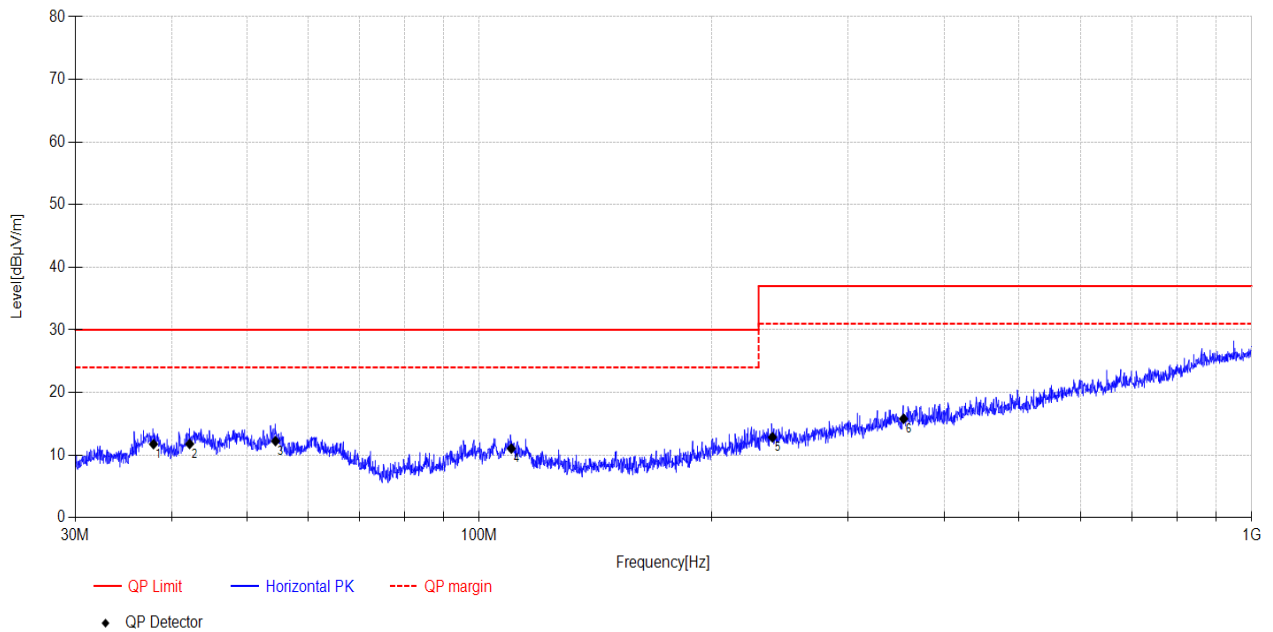

Final Data List								
NO.	Freq. [MHz]	Reading [dBµV]	Factor [dB]	Result [dBµV/m]	Limit [dBµV/m]	Margin [dB]	Detector	Polarity
1	37.88	28.66	-16.92	11.74	30.00	18.26	QP	Horizontal
2	42.19	27.27	-15.49	11.78	30.00	18.22	QP	Horizontal
3	54.49	27.68	-15.45	12.23	30.00	17.77	QP	Horizontal
4	110.05	27.37	-16.33	11.04	30.00	18.96	QP	Horizontal
5	239.65	27.94	-15.10	12.84	37.00	24.16	QP	Horizontal
6	354.28	27.22	-11.43	15.79	37.00	21.21	QP	Horizontal

Note: 1. Result Level = Reading + Factor.  
 2. If Peak Result complies with QP limit, QP Result is deemed to comply with QP limit.  
 3. Test setup: RBW: 120 kHz, VBW: 300 kHz, Sweep time: auto.

# TR-4-E-009 Radiated Emission Test Result

**Test Date:** 2025-10-15      **Tested By:** Mende Guo  
**EUT:** PORTABLE BLUETOOTH SPEAKER      **Model Number:** GO5D  
**Test Mode:** Charging + Bluetooth mode      **Power Supply:** AC 240V/50Hz  
**Condition:** Temp:22.8°C;Humi:54.2%      **Test Site:** DDT 10M Chamber  
**File Path:** d:\ts\2025 report data\Q25091711-2E\1015 10M RE\24  
**Memo:** S25091711-003

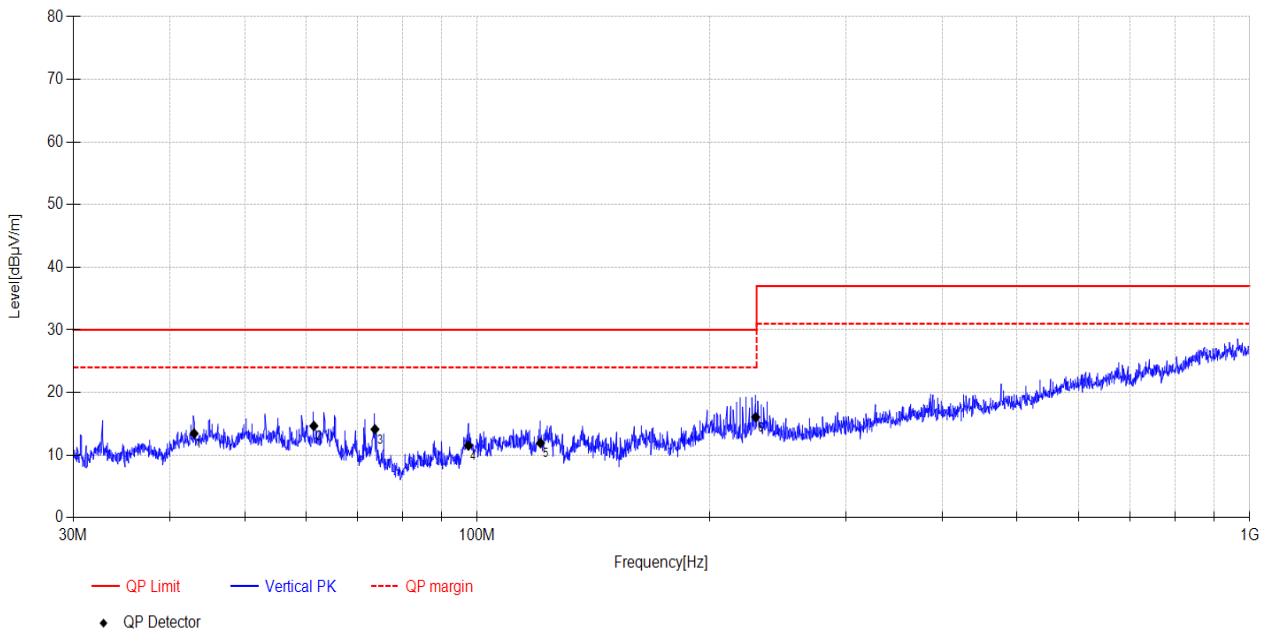

Final Data List								
NO.	Freq. [MHz]	Reading [dBμV]	Factor [dB]	Result [dBμV/m]	Limit [dBμV/m]	Margin [dB]	Detector	Polarity
1	43.01	28.26	-14.82	13.44	30.00	16.56	QP	Vertical
2	61.44	30.14	-15.49	14.65	30.00	15.35	QP	Vertical
3	73.73	33.25	-19.13	14.12	30.00	15.88	QP	Vertical
4	97.43	28.06	-16.54	11.52	30.00	18.48	QP	Vertical
5	120.76	29.73	-17.80	11.93	30.00	18.07	QP	Vertical
6	229.38	30.72	-14.66	16.06	30.00	13.94	QP	Vertical

Note: 1. Result Level = Reading + Factor.  
 2. If Peak Result complies with QP limit, QP Result is deemed to comply with QP limit.  
 3. Test setup: RBW: 120 kHz, VBW: 300 kHz, Sweep time: auto.

# TR-4-E-009 Radiated Emission Test Result

**Test Date:** 2025-10-15      **Tested By:** Mende Guo  
**EUT:** PORTABLE BLUETOOTH SPEAKER      **Model Number:** GO5D  
**Test Mode:** Bluetooth mode      **Power Supply:** Battery  
**Condition:** Temp:22.8°C;Humi:54.2%      **Test Site:** DDT 10M Chamber  
**File Path:** d:\ts\2025 report data\Q25091711-2E\1015 10M RE\25  
**Memo:** S25091711-003

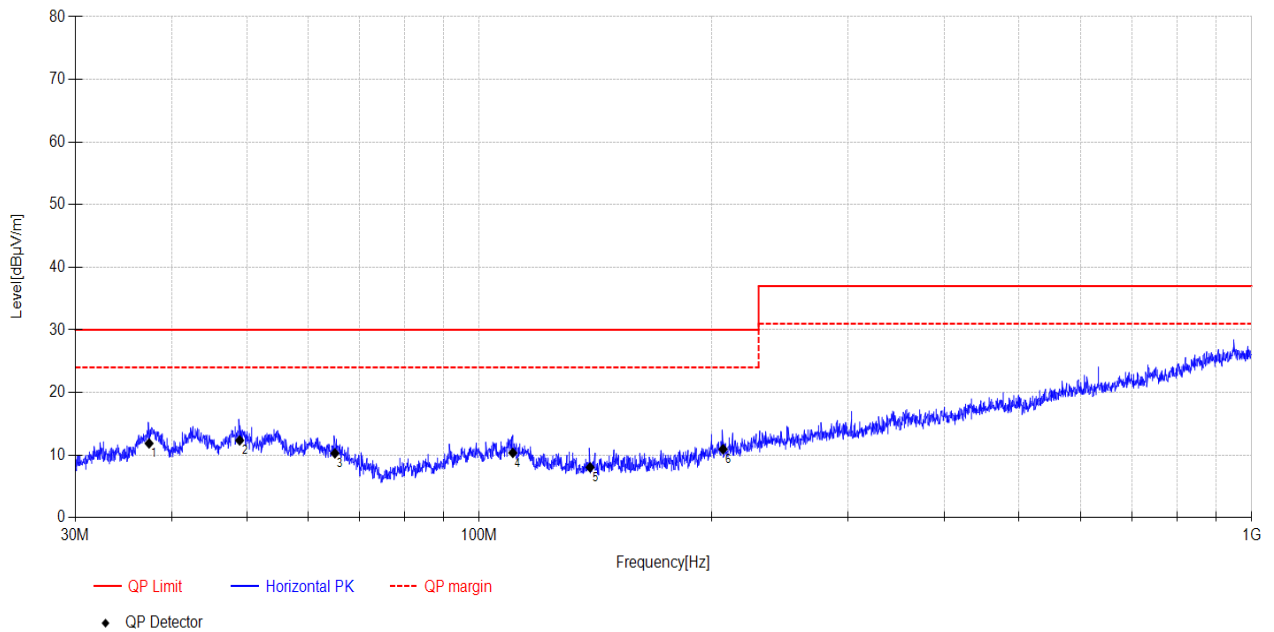

Final Data List								
NO.	Freq. [MHz]	Reading [dBµV]	Factor [dB]	Result [dBµV/m]	Limit [dBµV/m]	Margin [dB]	Detector	Polarity
1	37.38	28.74	-16.88	11.86	30.00	18.14	QP	Horizontal
2	48.97	28.05	-15.70	12.35	30.00	17.65	QP	Horizontal
3	65.04	26.89	-16.61	10.28	30.00	19.72	QP	Horizontal
4	110.53	26.88	-16.52	10.36	30.00	19.64	QP	Horizontal
5	139.19	27.8	-19.76	8.04	30.00	21.96	QP	Horizontal
6	206.84	27.73	-16.79	10.94	30.00	19.06	QP	Horizontal

- Note: 1. Result Level = Reading + Factor.  
 2. If Peak Result complies with QP limit, QP Result is deemed to comply with QP limit.  
 3. Test setup: RBW: 120 kHz, VBW: 300 kHz, Sweep time: auto.

# TR-4-E-009 Radiated Emission Test Result

**Test Date:** 2025-10-15      **Tested By:** Mende Guo  
**EUT:** PORTABLE BLUETOOTH SPEAKER      **Model Number:** GO5D  
**Test Mode:** Bluetooth mode      **Power Supply:** Battery  
**Condition:** Temp:22.8°C;Humi:54.2%      **Test Site:** DDT 10M Chamber  
**File Path:** d:\ts\2025 report data\Q25091711-2E\1015 10M RE\26  
**Memo:** S25091711-003

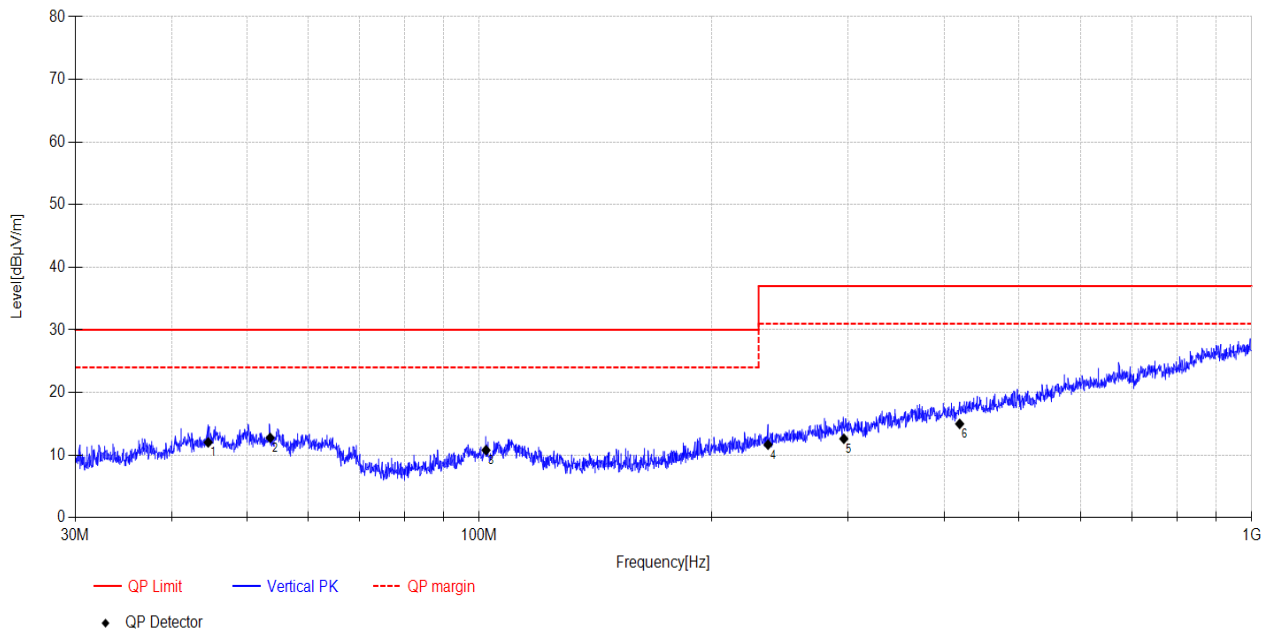

Final Data List								
NO.	Freq. [MHz]	Reading [dBµV]	Factor [dB]	Result [dBµV/m]	Limit [dBµV/m]	Margin [dB]	Detector	Polarity
1	44.58	26.49	-14.46	12.03	30.00	17.97	QP	Vertical
2	53.64	27.49	-14.74	12.75	30.00	17.25	QP	Vertical
3	102.06	27.23	-16.45	10.78	30.00	19.22	QP	Vertical
4	236.52	26.31	-14.65	11.66	37.00	25.34	QP	Vertical
5	296.53	25.14	-12.53	12.61	37.00	24.39	QP	Vertical
6	418.83	24.76	-9.78	14.98	37.00	22.02	QP	Vertical

Note: 1. Result Level = Reading + Factor.  
 2. If Peak Result complies with QP limit, QP Result is deemed to comply with QP limit.  
 3. Test setup: RBW: 120 kHz, VBW: 300 kHz, Sweep time: auto.

# TR-4-E-009 Radiated Emission Test Result

**Test Date:** 2025-10-15 **Tested By:** Mende Guo  
**EUT:** PORTABLE BLUETOOTH SPEAKER **Model Number:** GO5D  
**Test Mode:** Charging + Bluetooth + TWS mode **Power Supply:** AC 240V/50Hz  
**Condition:** Temp:22.8°C;Humi:54.2% **Test Site:** DDT 10M Chamber  
**File Path:** d:\ts\2025 report data\Q25091711-2E\1015 10M RE\27  
**Memo:** S25091711-003

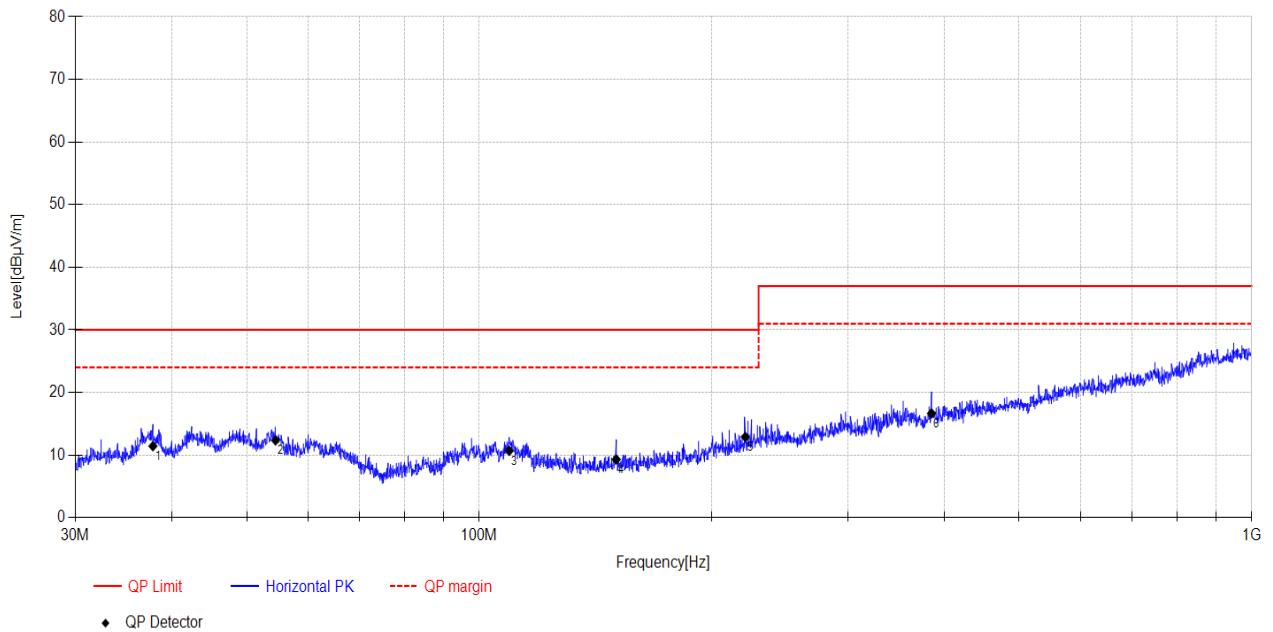

Final Data List								
NO.	Freq. [MHz]	Reading [dBμV]	Factor [dB]	Result [dBμV/m]	Limit [dBμV/m]	Margin [dB]	Detector	Polarity
1	37.81	28.34	-16.91	11.43	30.00	18.57	QP	Horizontal
2	54.49	27.8	-15.45	12.35	30.00	17.65	QP	Horizontal
3	109.38	27	-16.31	10.69	30.00	19.31	QP	Horizontal
4	150.48	28.74	-19.44	9.30	30.00	20.70	QP	Horizontal
5	221.09	29.22	-16.32	12.90	30.00	17.10	QP	Horizontal
6	385.03	27.59	-10.93	16.66	37.00	20.34	QP	Horizontal

Note: 1. Result Level = Reading + Factor.

2. If Peak Result complies with QP limit, QP Result is deemed to comply with QP limit.

3. Test setup: RBW: 120 kHz, VBW: 300 kHz, Sweep time: auto.

# TR-4-E-009 Radiated Emission Test Result

**Test Date:** 2025-10-15      **Tested By:** Mende Guo  
**EUT:** PORTABLE BLUETOOTH SPEAKER      **Model Number:** GO5D  
**Test Mode:** Charging + Bluetooth + TWS mode      **Power Supply:** AC 240V/50Hz  
**Condition:** Temp:22.8°C;Humi:54.2%      **Test Site:** DDT 10M Chamber  
**File Path:** d:\ts\2025 report data\Q25091711-2E\1015 10M RE\28  
**Memo:** S25091711-003

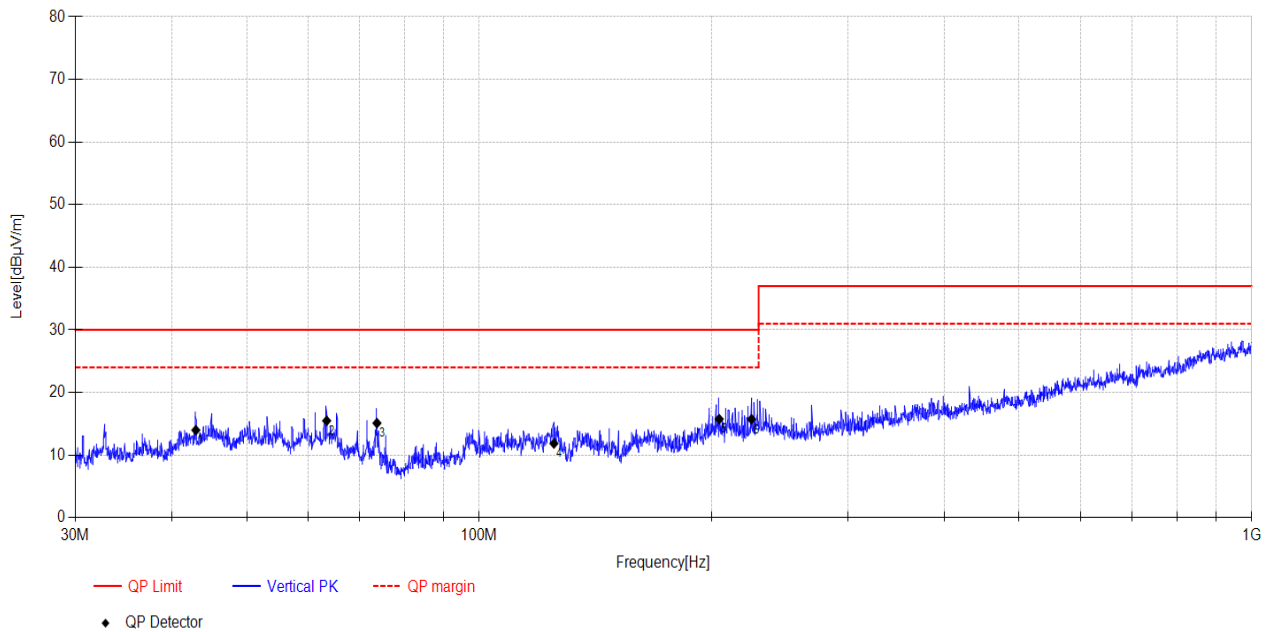

Final Data List								
NO.	Freq. [MHz]	Reading [dBμV]	Factor [dB]	Result [dBμV/m]	Limit [dBμV/m]	Margin [dB]	Detector	Polarity
1	42.97	28.8	-14.82	13.98	30.00	16.02	QP	Vertical
2	63.47	31.36	-15.88	15.48	30.00	14.52	QP	Vertical
3	73.73	34.23	-19.13	15.10	30.00	14.90	QP	Vertical
4	124.96	30	-18.15	11.85	30.00	18.15	QP	Vertical
5	204.50	31.49	-15.74	15.75	30.00	14.25	QP	Vertical
6	225.19	30.82	-15.10	15.72	30.00	14.28	QP	Vertical

Note: 1. Result Level = Reading + Factor.

2. If Peak Result complies with QP limit, QP Result is deemed to comply with QP limit.

3. Test setup: RBW: 120 kHz, VBW: 300 kHz, Sweep time: auto.

# TR-4-E-009 Radiated Emission Test Result

**Test Date:** 2025-10-15      **Tested By:** Mende Guo  
**EUT:** PORTABLE BLUETOOTH SPEAKER      **Model Number:** GO5D  
**Test Mode:** Charging + Bluetooth + TWS mode      **Power Supply:** AC 120V/60Hz  
**Condition:** Temp:22.8°C;Humi:54.2%      **Test Site:** DDT 10M Chamber  
**File Path:** d:\ts\2025 report data\Q25091711-2E\1015 10M RE\29  
**Memo:** S25091711-003

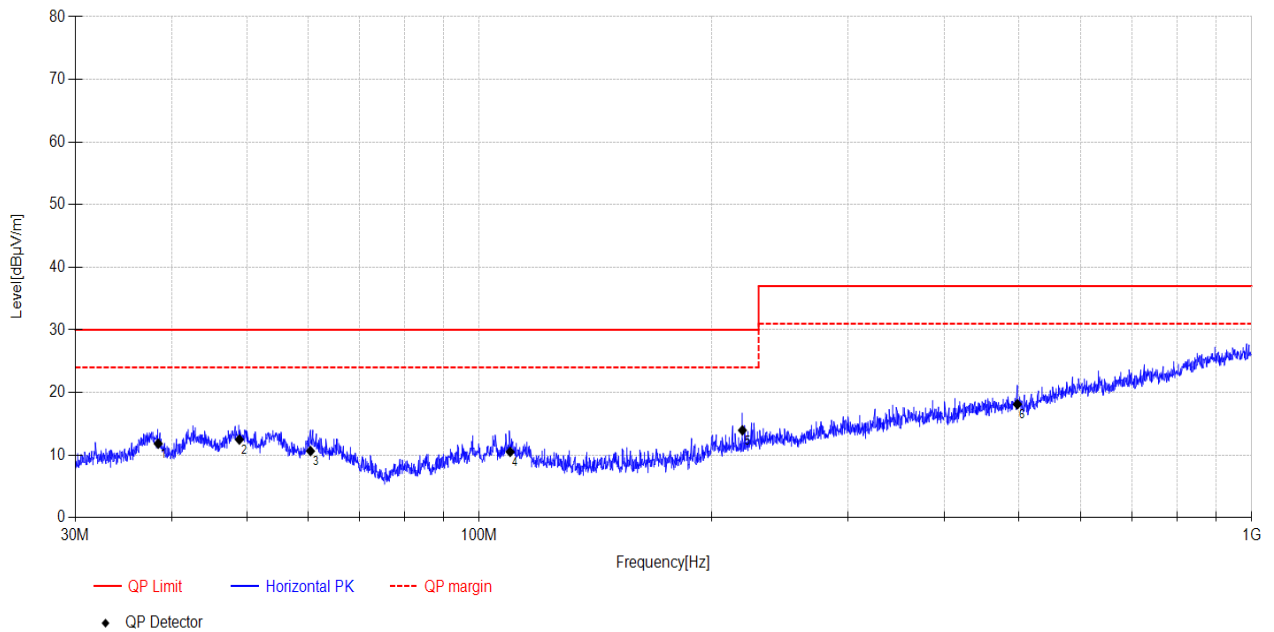

Final Data List								
NO.	Freq. [MHz]	Reading [dBµV]	Factor [dB]	Result [dBµV/m]	Limit [dBµV/m]	Margin [dB]	Detector	Polarity
1	38.41	28.81	-16.99	11.82	30.00	18.18	QP	Horizontal
2	48.92	28.16	-15.68	12.48	30.00	17.52	QP	Horizontal
3	60.48	26.84	-16.20	10.64	30.00	19.36	QP	Horizontal
4	109.66	26.83	-16.31	10.52	30.00	19.48	QP	Horizontal
5	219.16	30.44	-16.49	13.95	30.00	16.05	QP	Horizontal
6	497.33	27.21	-9.10	18.11	37.00	18.89	QP	Horizontal

Note: 1. Result Level = Reading + Factor.  
 2. If Peak Result complies with QP limit, QP Result is deemed to comply with QP limit.  
 3. Test setup: RBW: 120 kHz, VBW: 300 kHz, Sweep time: auto.

# TR-4-E-009 Radiated Emission Test Result

**Test Date:** 2025-10-15      **Tested By:** Mende Guo  
**EUT:** PORTABLE BLUETOOTH SPEAKER      **Model Number:** GO5D  
**Test Mode:** Charging + Bluetooth + TWS mode      **Power Supply:** AC 120V/60Hz  
**Condition:** Temp:22.8°C;Humi:54.2%      **Test Site:** DDT 10M Chamber  
**File Path:** d:\ts\2025 report data\Q25091711-2E\1015 10M RE\30  
**Memo:** S25091711-003

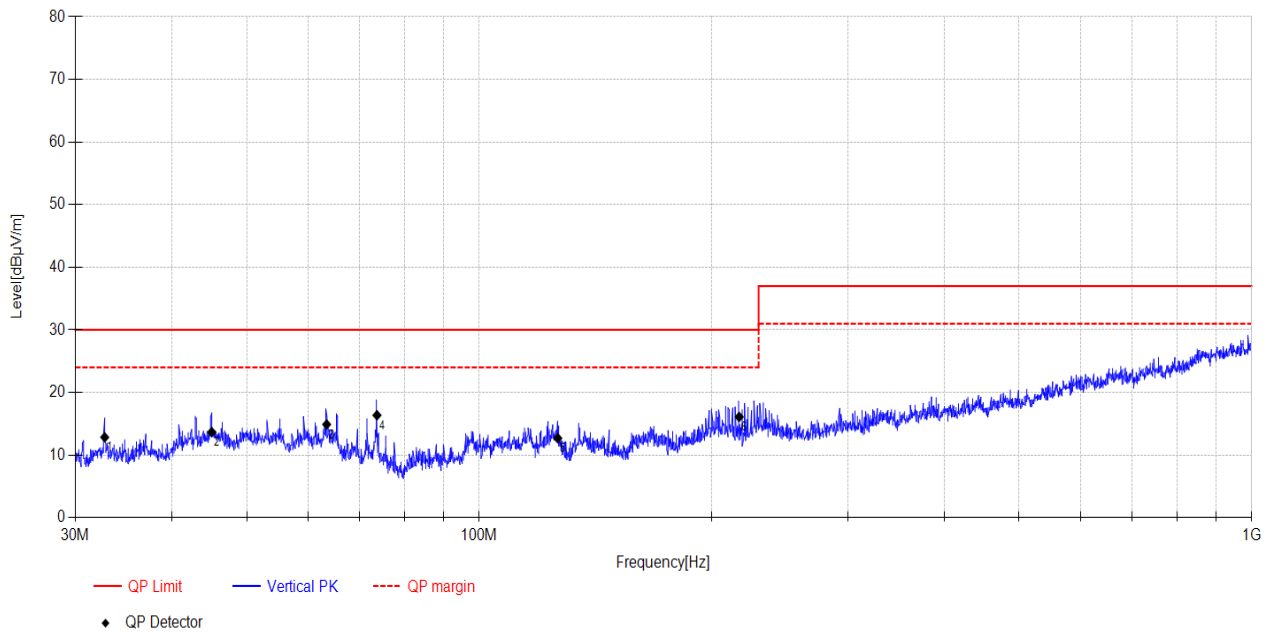

Final Data List								
NO.	Freq. [MHz]	Reading [dBµV]	Factor [dB]	Result [dBµV/m]	Limit [dBµV/m]	Margin [dB]	Detector	Polarity
1	32.75	30.41	-17.57	12.84	30.00	17.16	QP	Vertical
2	45.05	28.16	-14.49	13.67	30.00	16.33	QP	Vertical
3	63.47	30.78	-15.88	14.90	30.00	15.10	QP	Vertical
4	73.73	35.49	-19.13	16.36	30.00	13.64	QP	Vertical
5	126.39	30.65	-17.95	12.70	30.00	17.30	QP	Vertical
6	217.06	31.42	-15.32	16.10	30.00	13.90	QP	Vertical

Note: 1. Result Level = Reading + Factor.  
 2. If Peak Result complies with QP limit, QP Result is deemed to comply with QP limit.  
 3. Test setup: RBW: 120 kHz, VBW: 300 kHz, Sweep time: auto.

# TR-4-E-009 Radiated Emission Test Result

**Test Date:** 2025-10-15      **Tested By:** Mende Guo  
**EUT:** PORTABLE BLUETOOTH SPEAKER      **Model Number:** GO5D  
**Test Mode:** Bluetooth + TWS mode      **Power Supply:** Battery  
**Condition:** Temp:22.8°C;Humi:54.2%      **Test Site:** DDT 10M Chamber  
**File Path:** d:\ts\2025 report data\Q25091711-2E\1015 10M RE\31  
**Memo:** S25091711-003

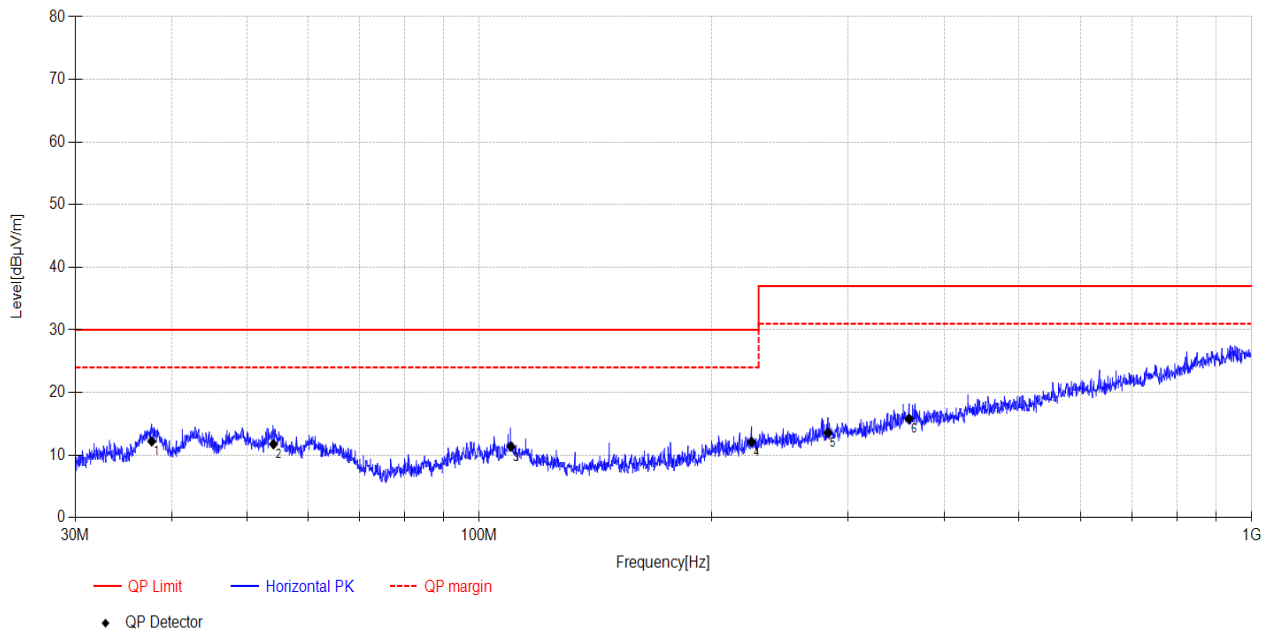

Final Data List								
NO.	Freq. [MHz]	Reading [dBμV]	Factor [dB]	Result [dBμV/m]	Limit [dBμV/m]	Margin [dB]	Detector	Polarity
1	37.68	29.1	-16.91	12.19	30.00	17.81	QP	Horizontal
2	54.16	27.13	-15.39	11.74	30.00	18.26	QP	Horizontal
3	109.95	27.67	-16.31	11.36	30.00	18.64	QP	Horizontal
4	225.19	28.01	-15.90	12.11	30.00	17.89	QP	Horizontal
5	282.83	27.93	-14.37	13.56	37.00	23.44	QP	Horizontal
6	360.22	27.54	-11.75	15.79	37.00	21.21	QP	Horizontal

Note: 1. Result Level = Reading + Factor.

2. If Peak Result complies with QP limit, QP Result is deemed to comply with QP limit.

3. Test setup: RBW: 120 kHz, VBW: 300 kHz, Sweep time: auto.

# TR-4-E-009 Radiated Emission Test Result

**Test Date:** 2025-10-15      **Tested By:** Mende Guo  
**EUT:** PORTABLE BLUETOOTH SPEAKER      **Model Number:** GO5D  
**Test Mode:** Bluetooth + TWS mode      **Power Supply:** Battery  
**Condition:** Temp:22.8°C;Humi:54.2%      **Test Site:** DDT 10M Chamber  
**File Path:** d:\ts\2025 report data\Q25091711-2E\1015 10M RE\32  
**Memo:** S25091711-003

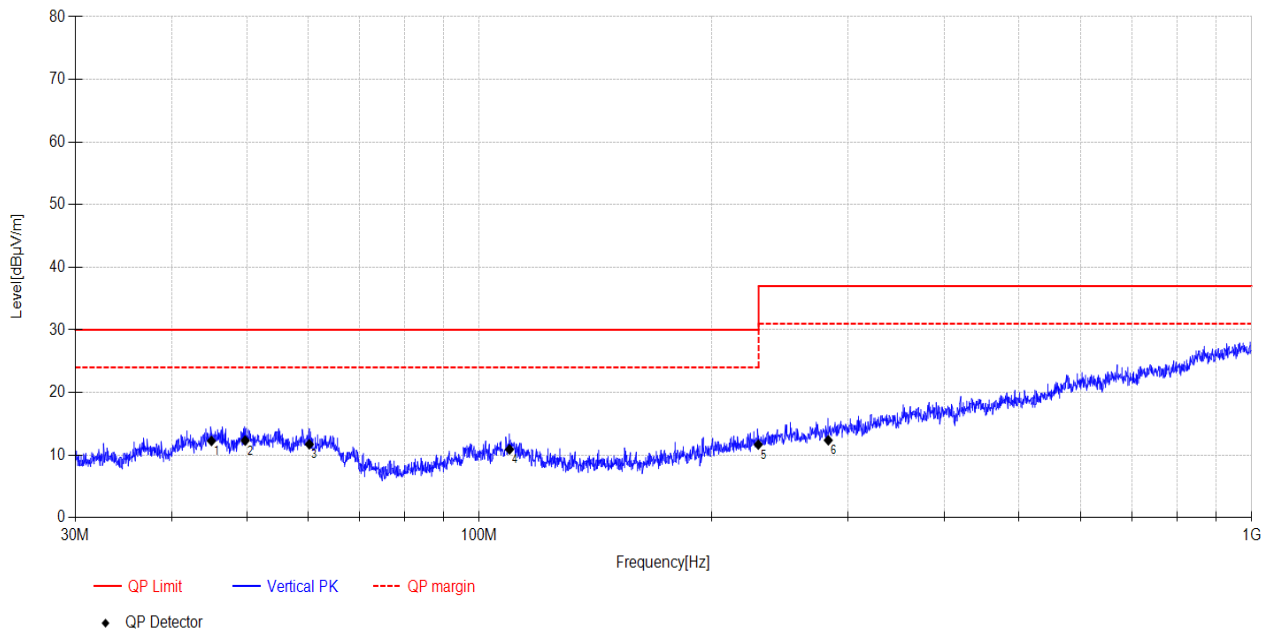

Final Data List								
NO.	Freq. [MHz]	Reading [dBµV]	Factor [dB]	Result [dBµV/m]	Limit [dBµV/m]	Margin [dB]	Detector	Polarity
1	45.01	26.75	-14.49	12.26	30.00	17.74	QP	Vertical
2	49.79	26.67	-14.35	12.32	30.00	17.68	QP	Vertical
3	60.27	26.94	-15.21	11.73	30.00	18.27	QP	Vertical
4	109.47	26.33	-15.42	10.91	30.00	19.09	QP	Vertical
5	229.78	26.28	-14.61	11.67	30.00	18.33	QP	Vertical
6	283.07	25.65	-13.28	12.37	37.00	24.63	QP	Vertical

- Note: 1. Result Level = Reading + Factor.  
 2. If Peak Result complies with QP limit, QP Result is deemed to comply with QP limit.  
 3. Test setup: RBW: 120 kHz, VBW: 300 kHz, Sweep time: auto.

# TR-4-E-009 Radiated Emission Test Result

**Test Site** : DDT 3m Chamber 1# D:\2025 RE 1# Report data\Q25091711-2E\1010 RE-H.EM6  
**Test Date** : 2025-10-11 **Tested By** : Li guilin  
**Power Supply** : Battery **Test Mode** : Bluetooth mode  
**Condition** : Temp:19.2°C, Humi:60.9% **Antenna/Distance** : 2025 9120D 1#/3m/  
VERTICAL  
**Memo** : S25091711-003

Data: 65

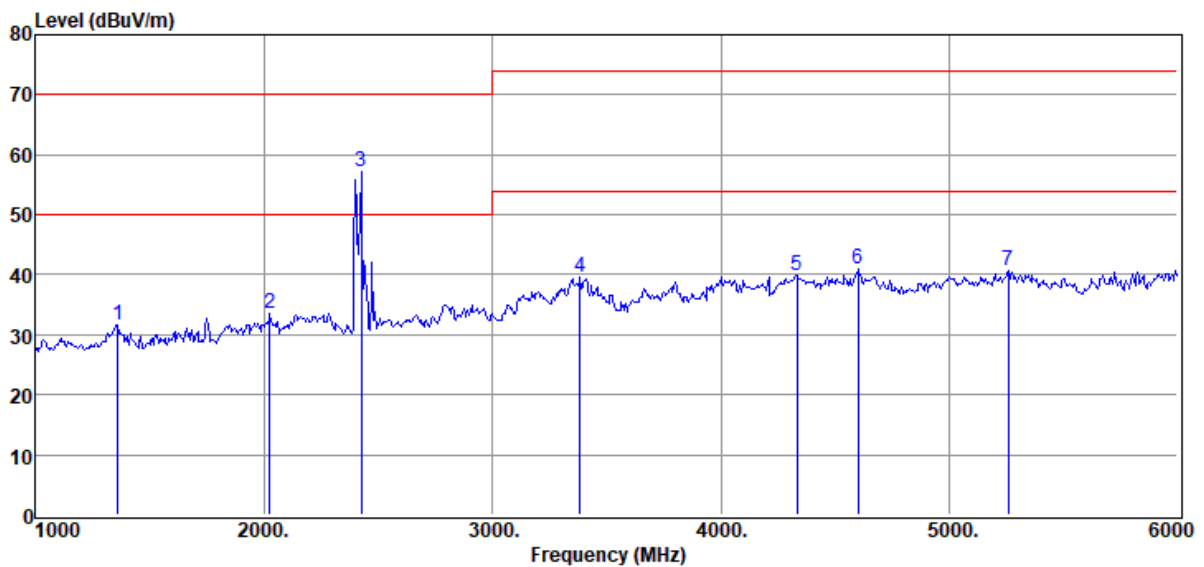

Item (Mark)	Freq. (MHz)	Read Level (dBuV)	Antenna Factor (dB/m)	PRM Factor dB	Cable Loss dB	Result Level (dBuV/m)	Limit Line (dBuV/m)	Margin (dB)	Detector	Polarization
1	1360.00	55.10	25.60	52.84	3.82	31.68	70.00	38.32	Peak	VERTICAL
2	2025.00	55.46	26.35	53.10	4.83	33.54	70.00	36.46	Peak	VERTICAL
3	2425.00	77.49	27.70	53.06	5.16	57.29	Carrier frequency		VERTICAL	
4	3385.00	58.35	28.61	53.23	5.97	39.70	74.00	34.30	Peak	VERTICAL
5	4335.00	56.44	30.34	53.47	6.68	39.99	74.00	34.01	Peak	VERTICAL
6	4600.00	56.58	31.00	53.36	6.81	41.03	74.00	32.97	Peak	VERTICAL
7	5260.00	54.06	32.92	53.54	7.18	40.62	74.00	33.38	Peak	VERTICAL

Note: 1. Result Level = Read Level + Antenna Factor + Cable loss - PRM Factor.

2. If Peak Result complies with AV limit, AV Result is deemed to comply with AV limit.

3. Test setup: RBW: 1 MHz, VBW: 3 MHz, Sweep time: auto.

4. According to standard requirements, the radio carrier and harmonic frequencies of the samples are not included in the test results.

# TR-4-E-009 Radiated Emission Test Result

**Test Site** : DDT 3m Chamber 1# D:\2025 RE 1# Report data\Q25091711-2E\1010 RE-H.EM6  
**Test Date** : 2025-10-11 **Tested By** : Li guilin  
**Power Supply** : Battery **Test Mode** : Bluetooth mode  
**Condition** : Temp:19.2°C, Humi:60.9% **Antenna/Distance** : 2025 9120D 1#/3m/  
HORIZONTAL  
**Memo** : S25091711-003

Data: 66

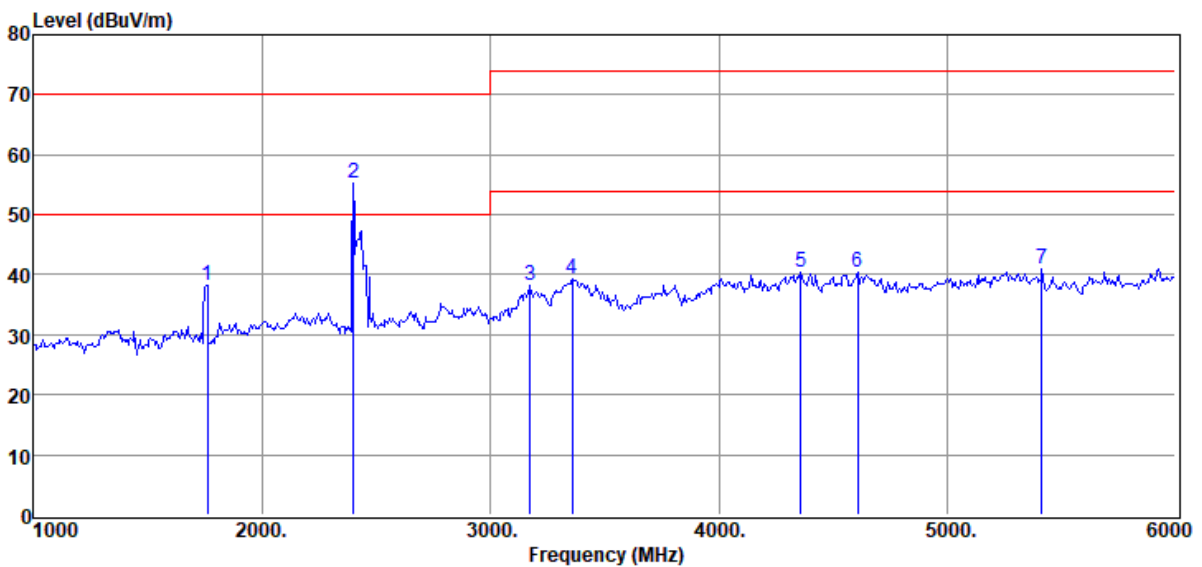

Item (Mark)	Freq. (MHz)	Read Level (dBuV)	Antenna Factor (dB/m)	PRM Factor dB	Cable Loss dB	Result Level (dBuV/m)	Limit Line (dBuV/m)	Margin (dB)	Detector	Polarization
1	1760.00	61.51	25.20	53.00	4.44	38.15	70.00	31.85	Peak	HORIZONTAL
2	2400.00	75.50	27.60	53.06	5.14	55.18	Carrier frequency			HORIZONTAL
3	3175.00	56.90	28.60	53.10	5.79	38.19	74.00	35.81	Peak	HORIZONTAL
4	3360.00	57.61	28.96	53.22	5.95	39.30	74.00	34.70	Peak	HORIZONTAL
5	4360.00	56.63	30.48	53.46	6.69	40.34	74.00	33.66	Peak	HORIZONTAL
6	4610.00	55.77	31.10	53.36	6.81	40.32	74.00	33.68	Peak	HORIZONTAL
7	5415.00	54.60	32.91	53.74	7.29	41.06	74.00	32.94	Peak	HORIZONTAL

Note: 1. Result Level = Read Level + Antenna Factor + Cable loss - PRM Factor.

2. If Peak Result complies with AV limit, AV Result is deemed to comply with AV limit.

3. Test setup: RBW: 1 MHz, VBW: 3 MHz, Sweep time: auto.

4. According to standard requirements, the radio carrier and harmonic frequencies of the samples are not included in the test results.

# TR-4-E-009 Radiated Emission Test Result

Test Site : DDT 3m Chamber 1#

D:\2025 RE 1# Report data\Q25091711-2E\1010 RE-H.EM6

Test Date : 2025-10-11

Tested By : Li guilin

Power Supply : Battery

Test Mode : Bluetooth + TWS mode

Condition : Temp:19.2°C, Humi:60.9%

Antenna/Distance : 2025 9120D 1#/3m/  
HORIZONTAL

Memo : S25091711-003

Data: 67

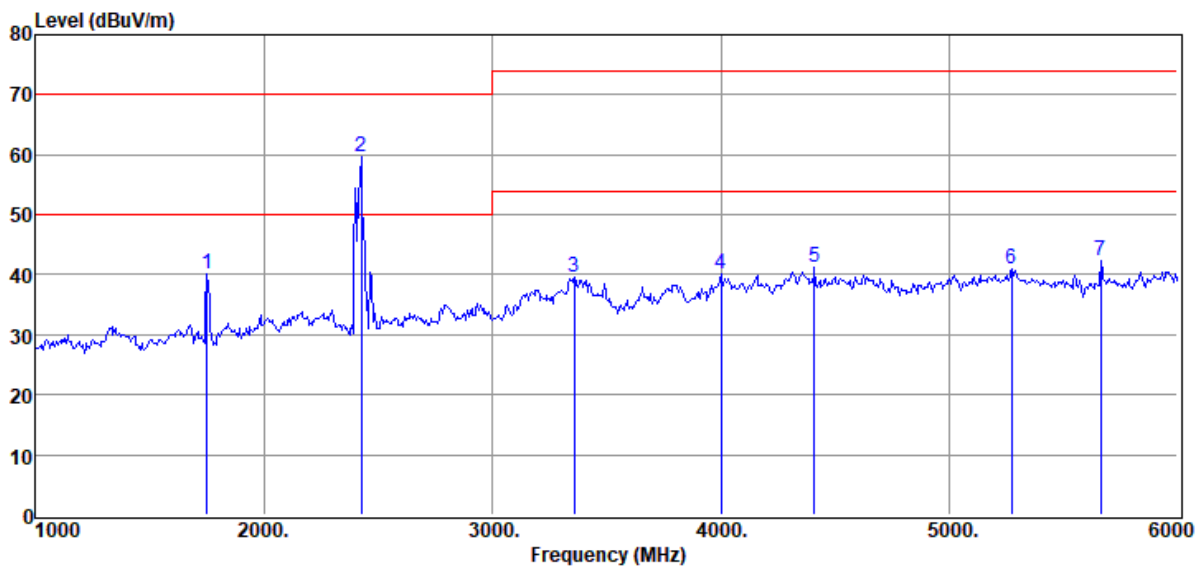

Item (Mark)	Freq. (MHz)	Read Level (dBuV)	Antenna Factor (dB/m)	PRM Factor dB	Cable Loss dB	Result Level (dBuV/m)	Limit Line (dBuV/m)	Margin (dB)	Detector	Polarization
1	1750.00	63.61	25.20	53.00	4.43	40.24	70.00	29.76	Peak	HORIZONTAL
2	2425.00	79.95	27.70	53.06	5.16	59.75	Carrier frequency			HORIZONTAL
3	3360.00	57.81	28.96	53.22	5.95	39.50	74.00	34.50	Peak	HORIZONTAL
4	4000.00	57.32	29.90	53.60	6.52	40.14	74.00	33.86	Peak	HORIZONTAL
5	4410.00	57.25	30.82	53.44	6.72	41.35	74.00	32.65	Peak	HORIZONTAL
6	5275.00	54.48	32.80	53.56	7.19	40.91	74.00	33.09	Peak	HORIZONTAL
7	5665.00	56.01	32.85	54.06	7.47	42.27	74.00	31.73	Peak	HORIZONTAL

Note: 1. Result Level = Read Level + Antenna Factor + Cable loss - PRM Factor.

2. If Peak Result complies with AV limit, AV Result is deemed to comply with AV limit.

3. Test setup: RBW: 1 MHz, VBW: 3 MHz, Sweep time: auto.

4. According to standard requirements, the radio carrier and harmonic frequencies of the samples are not included in the test results.

# TR-4-E-009 Radiated Emission Test Result

**Test Site** : DDT 3m Chamber 1# D:\2025 RE 1# Report data\Q25091711-2E\1010 RE-H.EM6  
**Test Date** : 2025-10-11 **Tested By** : Li guilin  
**Power Supply** : Battery **Test Mode** : Bluetooth + TWS mode  
**Condition** : Temp:19.2°C, Humi:60.9% **Antenna/Distance** : 2025 9120D 1#/3m/  
VERTICAL  
**Memo** : S25091711-003

Data: 68

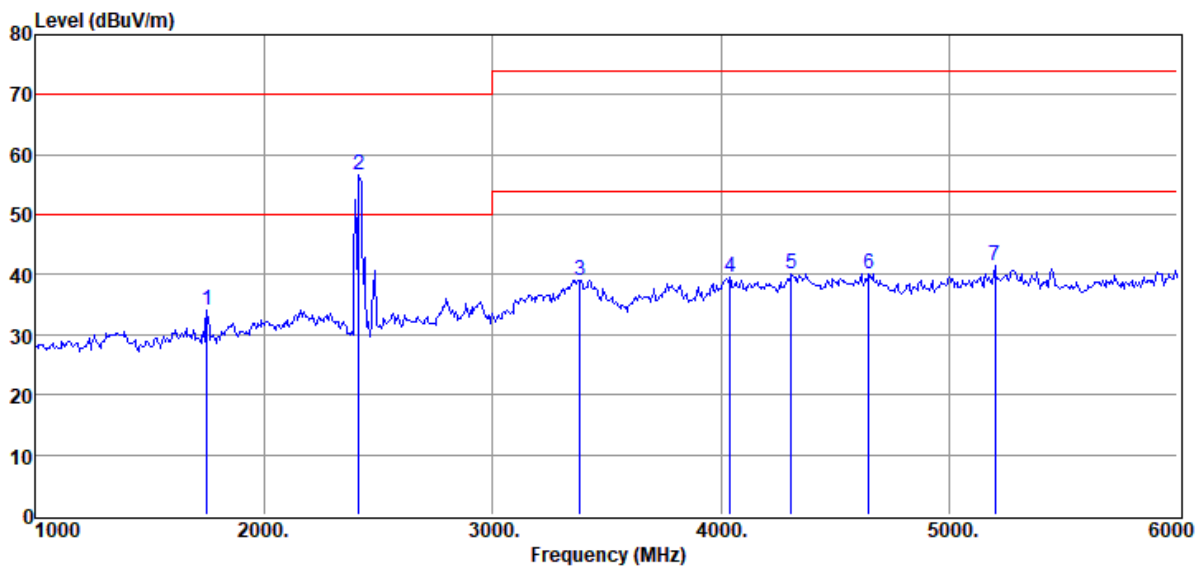

Item (Mark)	Freq. (MHz)	Read Level (dBuV)	Antenna Factor (dB/m)	PRM Factor dB	Cable Loss dB	Result Level (dBuV/m)	Limit Line (dBuV/m)	Margin (dB)	Detector	Polarization
1	1750.00	57.46	25.20	53.00	4.43	34.09	70.00	35.91	Peak	VERTICAL
2	2415.00	76.90	27.66	53.06	5.15	56.65	Carrier frequency			VERTICAL
3	3385.00	57.69	28.61	53.23	5.97	39.04	74.00	34.96	Peak	VERTICAL
4	4040.00	56.54	29.98	53.58	6.54	39.48	74.00	34.52	Peak	VERTICAL
5	4310.00	56.77	30.24	53.48	6.67	40.20	74.00	33.80	Peak	VERTICAL
6	4650.00	55.25	31.50	53.34	6.83	40.24	74.00	33.76	Peak	VERTICAL
7	5200.00	55.26	32.60	53.46	7.14	41.54	74.00	32.46	Peak	VERTICAL

Note: 1. Result Level = Read Level + Antenna Factor + Cable loss - PRM Factor.

2. If Peak Result complies with AV limit, AV Result is deemed to comply with AV limit.

3. Test setup: RBW: 1 MHz, VBW: 3 MHz, Sweep time: auto.

4. According to standard requirements, the radio carrier and harmonic frequencies of the samples are not included in the test results.

# TR-4-E-009 Radiated Emission Test Result

Test Site : DDT 3m Chamber 1#

D:\2025 RE 1# Report data\Q25091711-2E\1010 RE-H.EM6

Test Date : 2025-10-11

Tested By : Li guilin

Power Supply : AC 240V/50Hz

Test Mode : Charging + Bluetooth + TWS mode

Condition : Temp:19.2°C, Humi:60.9%

Antenna/Distance : 2025 9120D 1#/3m/  
VERTICAL

Memo : S25091711-003

Data: 69

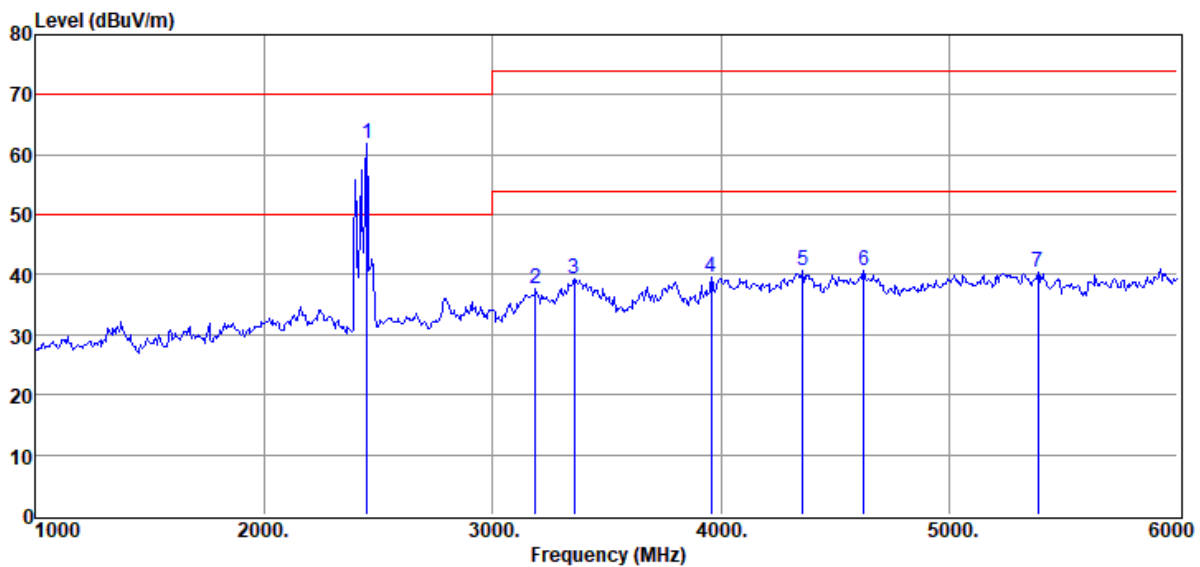

Item (Mark)	Freq. (MHz)	Read Level (dBuV)	Antenna Factor (dB/m)	PRM Factor dB	Cable Loss dB	Result Level (dBuV/m)	Limit Line (dBuV/m)	Margin (dB)	Detector	Polarization
1	2450.00	81.96	27.80	53.06	5.18	61.88	Carrier frequency		VERTICAL	
2	3190.00	56.27	28.66	53.11	5.80	37.62	74.00	36.38	Peak	VERTICAL
3	3360.00	57.73	28.96	53.22	5.95	39.42	74.00	34.58	Peak	VERTICAL
4	3960.00	56.91	29.74	53.58	6.48	39.55	74.00	34.45	Peak	VERTICAL
5	4360.00	56.88	30.48	53.46	6.69	40.59	74.00	33.41	Peak	VERTICAL
6	4625.00	55.86	31.25	53.35	6.82	40.58	74.00	33.42	Peak	VERTICAL
7	5390.00	53.93	32.84	53.71	7.27	40.33	74.00	33.67	Peak	VERTICAL

Note: 1. Result Level = Read Level + Antenna Factor + Cable loss - PRM Factor.

2. If Peak Result complies with AV limit, AV Result is deemed to comply with AV limit.

3. Test setup: RBW: 1 MHz, VBW: 3 MHz, Sweep time: auto.

4. According to standard requirements, the radio carrier and harmonic frequencies of the samples are not included in the test results.

# TR-4-E-009 Radiated Emission Test Result

**Test Site** : DDT 3m Chamber 1# **D:\2025 RE 1# Report data\Q25091711-2E\1010 RE-H.EM6**  
**Test Date** : 2025-10-11 **Tested By** : Li guilin  
**Power Supply** : AC 240V/50Hz **Test Mode** : Charging + Bluetooth + TWS mode  
**Condition** : Temp:19.2°C, Humi:60.9% **Antenna/Distance** : 2025 9120D 1#/3m/  
HORIZONTAL  
**Memo** : S25091711-003

Data: 70

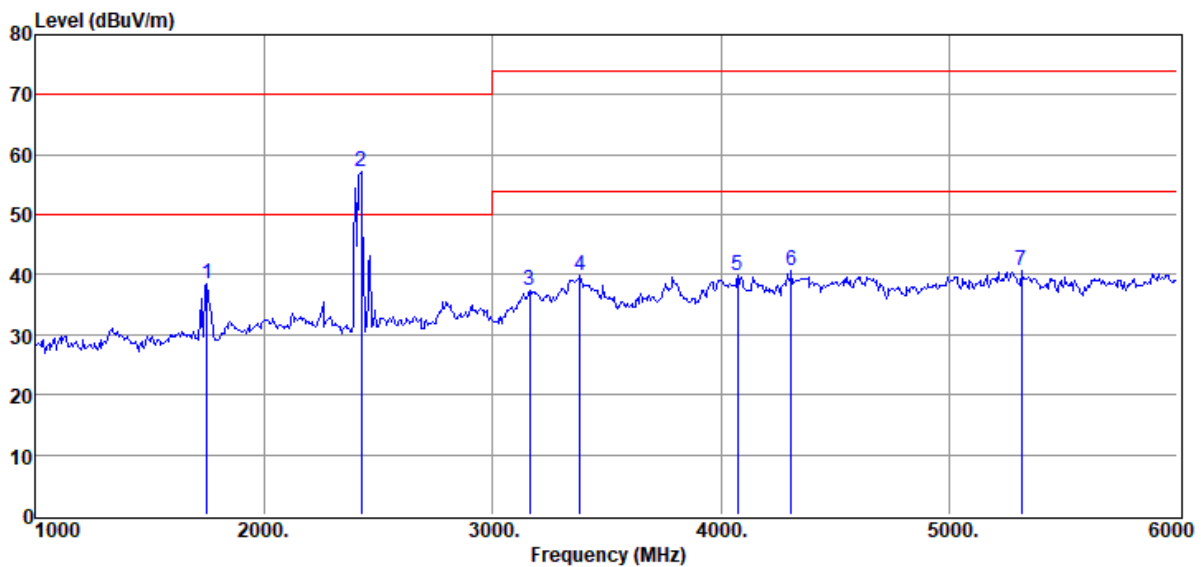

Item (Mark)	Freq. (MHz)	Read Level (dBuV)	Antenna Factor (dB/m)	PRM Factor dB	Cable Loss dB	Result Level (dBuV/m)	Limit Line (dBuV/m)	Margin (dB)	Detector	Polarization
1	1750.00	61.97	25.20	53.00	4.43	38.60	70.00	31.40	Peak	HORIZONTAL
2	2425.00	77.49	27.70	53.06	5.16	57.29	Carrier frequency			HORIZONTAL
3	3165.00	56.18	28.56	53.10	5.78	37.42	74.00	36.58	Peak	HORIZONTAL
4	3385.00	58.39	28.61	53.23	5.97	39.74	74.00	34.26	Peak	HORIZONTAL
5	4075.00	56.71	30.10	53.57	6.56	39.80	74.00	34.20	Peak	HORIZONTAL
6	4310.00	57.16	30.24	53.48	6.67	40.59	74.00	33.41	Peak	HORIZONTAL
7	5315.00	54.59	32.48	53.61	7.22	40.68	74.00	33.32	Peak	HORIZONTAL

Note: 1. Result Level = Read Level + Antenna Factor + Cable loss - PRM Factor.

2. If Peak Result complies with AV limit, AV Result is deemed to comply with AV limit.

3. Test setup: RBW: 1 MHz, VBW: 3 MHz, Sweep time: auto.

4. According to standard requirements, the radio carrier and harmonic frequencies of the samples are not included in the test results.

# TR-4-E-009 Radiated Emission Test Result

**Test Site** : DDT 3m Chamber 1# D:\2025 RE 1# Report data\Q25091711-2E\1010 RE-H.EM6  
**Test Date** : 2025-10-11 **Tested By** : Li guilin  
**Power Supply** : AC 120V/60Hz **Test Mode** : Charging + Bluetooth + TWS mode  
**Condition** : Temp:19.2°C, Humi:60.9% **Antenna/Distance** : 2025 9120D 1#/3m/  
HORIZONTAL  
**Memo** : S25091711-003

Data: 71

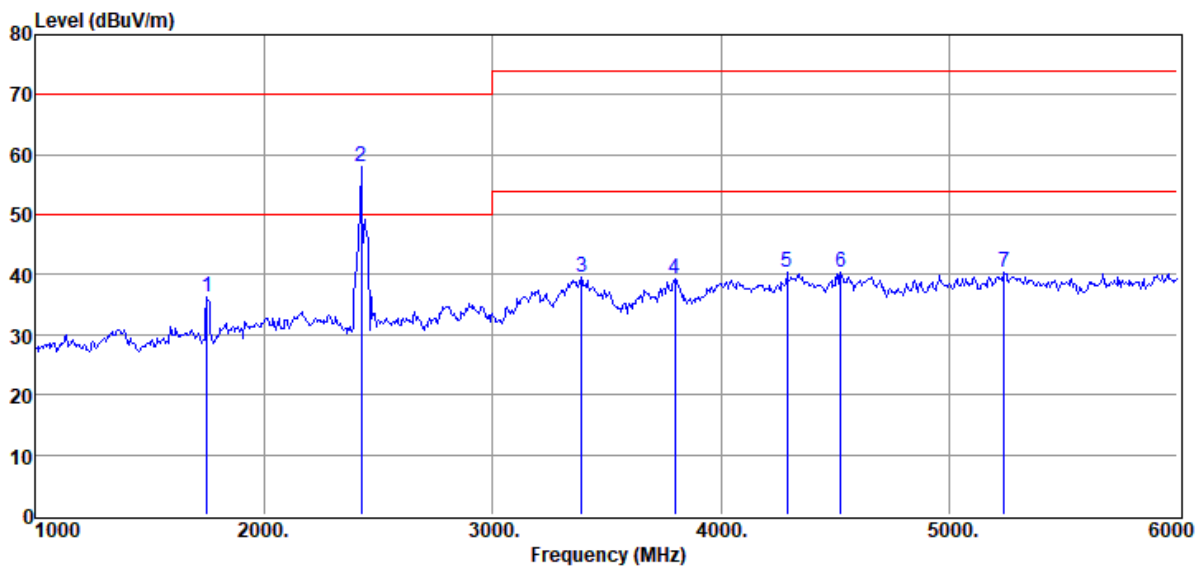

Item (Mark)	Freq. (MHz)	Read Level (dBuV)	Antenna Factor (dB/m)	PRM Factor dB	Cable Loss dB	Result Level (dBuV/m)	Limit Line (dBuV/m)	Margin (dB)	Detector	Polarization
1	1750.00	59.65	25.20	53.00	4.43	36.28	70.00	33.72	Peak	HORIZONTAL
2	2425.00	78.19	27.70	53.06	5.16	57.99	Carrier frequency			HORIZONTAL
3	3390.00	58.24	28.54	53.23	5.98	39.53	74.00	34.47	Peak	HORIZONTAL
4	3800.00	56.22	30.10	53.48	6.34	39.18	74.00	34.82	Peak	HORIZONTAL
5	4290.00	56.88	30.22	53.48	6.66	40.28	74.00	33.72	Peak	HORIZONTAL
6	4525.00	56.10	31.00	53.39	6.77	40.48	74.00	33.52	Peak	HORIZONTAL
7	5240.00	53.73	32.92	53.51	7.17	40.31	74.00	33.69	Peak	HORIZONTAL

Note: 1. Result Level = Read Level + Antenna Factor + Cable loss - PRM Factor.

2. If Peak Result complies with AV limit, AV Result is deemed to comply with AV limit.

3. Test setup: RBW: 1 MHz, VBW: 3 MHz, Sweep time: auto.

4. According to standard requirements, the radio carrier and harmonic frequencies of the samples are not included in the test results.

# TR-4-E-009 Radiated Emission Test Result

**Test Site** : DDT 3m Chamber 1# D:\2025 RE 1# Report data\Q25091711-2E\1010 RE-H.EM6  
**Test Date** : 2025-10-11 **Tested By** : Li guilin  
**Power Supply** : AC 120V/60Hz **Test Mode** : Charging + Bluetooth + TWS mode  
**Condition** : Temp:19.2°C, Humi:60.9% **Antenna/Distance** : 2025 9120D 1#/3m/  
VERTICAL  
**Memo** : S25091711-003

Data: 72

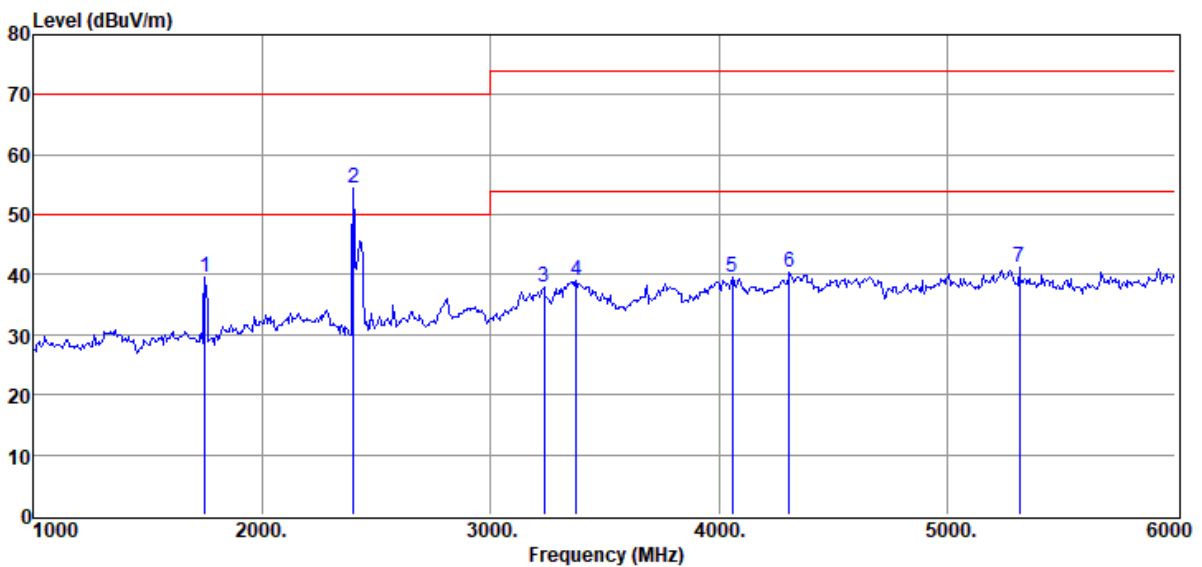

Item (Mark)	Freq. (MHz)	Read Level (dBuV)	Antenna Factor (dB/m)	PRM Factor dB	Cable Loss dB	Result Level (dBuV/m)	Limit Line (dBuV/m)	Margin (dB)	Detector	Polarization
1	1750.00	63.03	25.20	53.00	4.43	39.66	70.00	30.34	Peak	VERTICAL
2	2400.00	74.79	27.60	53.06	5.14	54.47	Carrier frequency			VERTICAL
3	3235.00	56.89	28.35	53.14	5.84	37.94	74.00	36.06	Peak	VERTICAL
4	3375.00	57.57	28.75	53.22	5.96	39.06	74.00	34.94	Peak	VERTICAL
5	4060.00	56.47	30.04	53.58	6.55	39.48	74.00	34.52	Peak	VERTICAL
6	4310.00	56.94	30.24	53.48	6.67	40.37	74.00	33.63	Peak	VERTICAL
7	5315.00	55.13	32.48	53.61	7.22	41.22	74.00	32.78	Peak	VERTICAL

Note: 1. Result Level = Read Level + Antenna Factor + Cable loss - PRM Factor.

2. If Peak Result complies with AV limit, AV Result is deemed to comply with AV limit.

3. Test setup: RBW: 1 MHz, VBW: 3 MHz, Sweep time: auto.

4. According to standard requirements, the radio carrier and harmonic frequencies of the samples are not included in the test results.

# TR-4-E-009 Radiated Emission Test Result

**Test Site** : DDT 3m Chamber 1# D:\2025 RE 1# Report data\Q25091711-2E\1010 RE-H.EM6  
**Test Date** : 2025-10-11 **Tested By** : Li guilin  
**Power Supply** : AC 120V/60Hz **Test Mode** : Charging + Bluetooth mode  
**Condition** : Temp:19.2°C, Humi:60.9% **Antenna/Distance** : 2025 9120D 1#/3m/  
VERTICAL  
**Memo** : S25091711-003

Data: 73

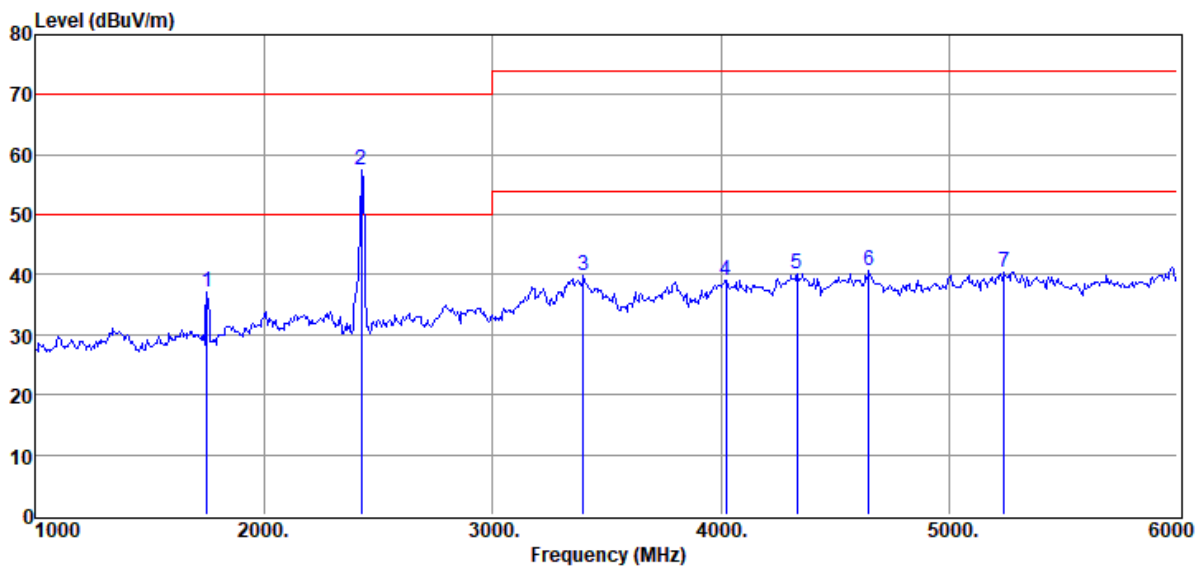

Item (Mark)	Freq. (MHz)	Read Level (dBuV)	Antenna Factor (dB/m)	PRM Factor dB	Cable Loss dB	Result Level (dBuV/m)	Limit Line (dBuV/m)	Margin (dB)	Detector	Polarization
1	1750.00	60.35	25.20	53.00	4.43	36.98	70.00	33.02	Peak	VERTICAL
2	2425.00	77.77	27.70	53.06	5.16	57.57	Carrier frequency			VERTICAL
3	3400.00	58.70	28.40	53.24	5.99	39.85	74.00	34.15	Peak	VERTICAL
4	4025.00	56.28	29.95	53.59	6.53	39.17	74.00	34.83	Peak	VERTICAL
5	4335.00	56.63	30.34	53.47	6.68	40.18	74.00	33.82	Peak	VERTICAL
6	4650.00	55.62	31.50	53.34	6.83	40.61	74.00	33.39	Peak	VERTICAL
7	5240.00	53.94	32.92	53.51	7.17	40.52	74.00	33.48	Peak	VERTICAL

Note: 1. Result Level = Read Level + Antenna Factor + Cable loss - PRM Factor.

2. If Peak Result complies with AV limit, AV Result is deemed to comply with AV limit.

3. Test setup: RBW: 1 MHz, VBW: 3 MHz, Sweep time: auto.

4. According to standard requirements, the radio carrier and harmonic frequencies of the samples are not included in the test results.

# TR-4-E-009 Radiated Emission Test Result

Test Site : DDT 3m Chamber 1#

D:\2025 RE 1# Report data\Q25091711-2E\1010 RE-H.EM6

Test Date : 2025-10-11

Tested By : Li guilin

Power Supply : AC 120V/60Hz

Test Mode : Charging + Bluetooth mode

Condition : Temp:19.2°C, Humi:60.9%

Antenna/Distance : 2025 9120D 1#/3m/  
HORIZONTAL

Memo : S25091711-003

Data: 74

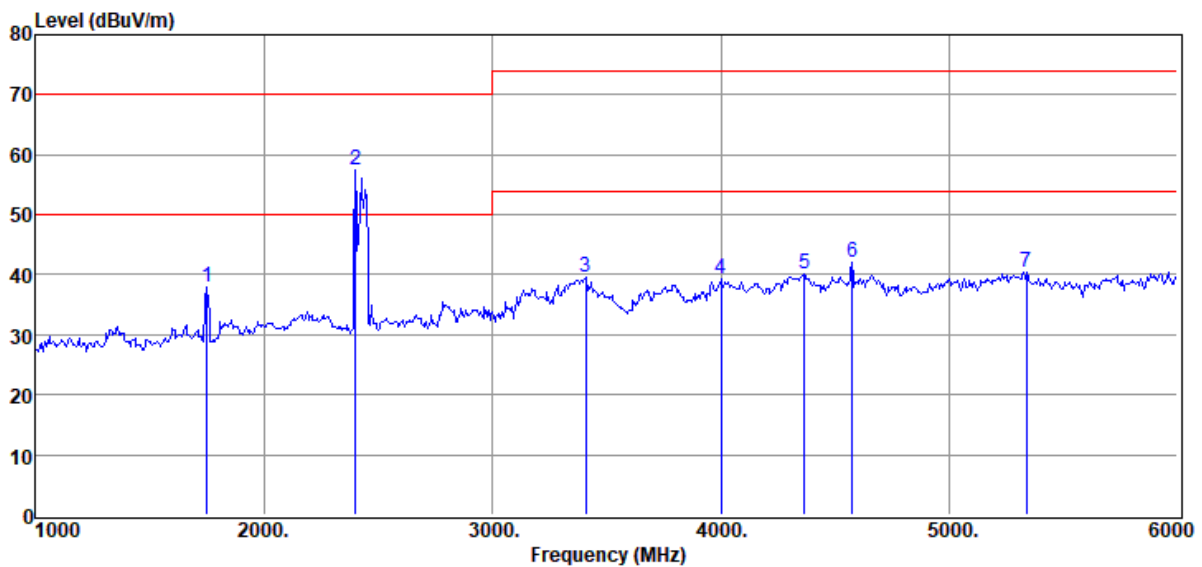

Item (Mark)	Freq. (MHz)	Read Level (dBuV)	Antenna Factor (dB/m)	PRM Factor dB	Cable Loss dB	Result Level (dBuV/m)	Limit Line (dBuV/m)	Margin (dB)	Detector	Polarization
1	1750.00	61.23	25.20	53.00	4.43	37.86	70.00	32.14	Peak	HORIZONTAL
2	2400.00	77.82	27.60	53.06	5.14	57.50	Carrier frequency			HORIZONTAL
3	3410.00	58.41	28.48	53.25	5.99	39.63	74.00	34.37	Peak	HORIZONTAL
4	4000.00	56.43	29.90	53.60	6.52	39.25	74.00	34.75	Peak	HORIZONTAL
5	4365.00	56.31	30.52	53.45	6.70	40.08	74.00	33.92	Peak	HORIZONTAL
6	4575.00	57.52	31.05	53.37	6.80	42.00	74.00	32.00	Peak	HORIZONTAL
7	5340.00	54.65	32.28	53.64	7.24	40.53	74.00	33.47	Peak	HORIZONTAL

Note: 1. Result Level = Read Level + Antenna Factor + Cable loss - PRM Factor.

2. If Peak Result complies with AV limit, AV Result is deemed to comply with AV limit.

3. Test setup: RBW: 1 MHz, VBW: 3 MHz, Sweep time: auto.

4. According to standard requirements, the radio carrier and harmonic frequencies of the samples are not included in the test results.

# TR-4-E-009 Radiated Emission Test Result

**Test Site** : DDT 3m Chamber 1# **D:\2025 RE 1# Report data\Q25091711-2E\1010 RE-H.EM6**  
**Test Date** : 2025-10-11 **Tested By** : Li guilin  
**Power Supply** : AC 240V/50Hz **Test Mode** : Charging + Bluetooth mode  
**Condition** : Temp:19.2°C, Humi:60.9% **Antenna/Distance** : 2025 9120D 1#/3m/  
HORIZONTAL  
**Memo** : S25091711-003

Data: 75

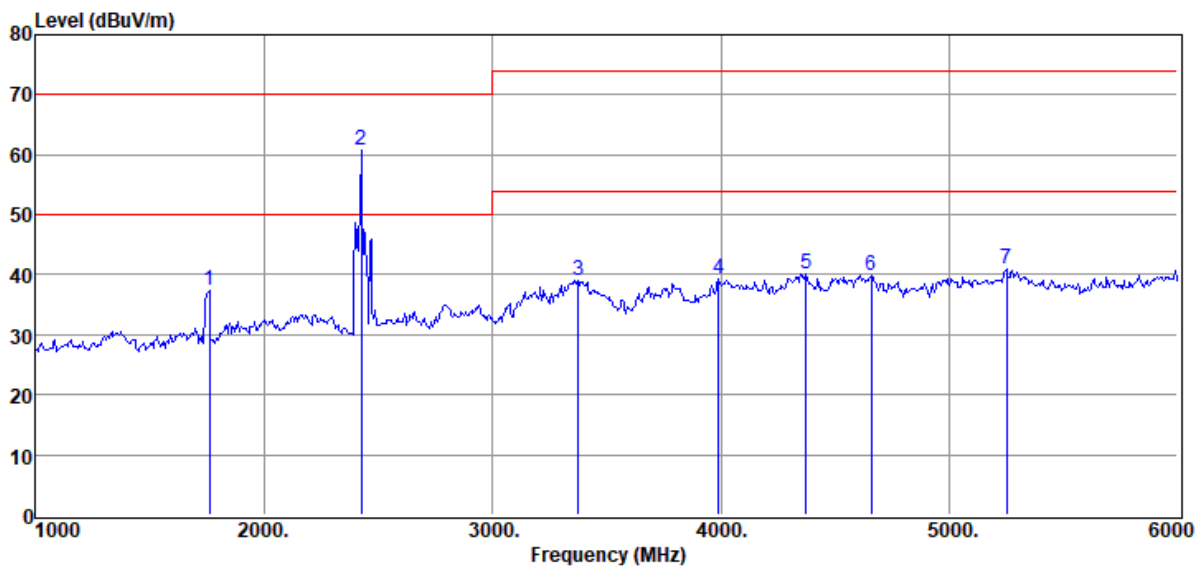

Item (Mark)	Freq. (MHz)	Read Level (dBuV)	Antenna Factor (dB/m)	PRM Factor dB	Cable Loss dB	Result Level (dBuV/m)	Limit Line (dBuV/m)	Margin (dB)	Detector	Polarization
1	1760.00	60.78	25.20	53.00	4.44	37.42	70.00	32.58	Peak	HORIZONTAL
2	2425.00	81.08	27.70	53.06	5.16	60.88	Carrier frequency			HORIZONTAL
3	3375.00	57.67	28.75	53.22	5.96	39.16	74.00	34.84	Peak	HORIZONTAL
4	3990.00	56.42	29.86	53.59	6.51	39.20	74.00	34.80	Peak	HORIZONTAL
5	4375.00	56.33	30.60	53.45	6.70	40.18	74.00	33.82	Peak	HORIZONTAL
6	4660.00	55.03	31.38	53.34	6.84	39.91	74.00	34.09	Peak	HORIZONTAL
7	5250.00	54.28	33.00	53.53	7.18	40.93	74.00	33.07	Peak	HORIZONTAL

Note: 1. Result Level = Read Level + Antenna Factor + Cable loss - PRM Factor.

2. If Peak Result complies with AV limit, AV Result is deemed to comply with AV limit.

3. Test setup: RBW: 1 MHz, VBW: 3 MHz, Sweep time: auto.

4. According to standard requirements, the radio carrier and harmonic frequencies of the samples are not included in the test results.

# TR-4-E-009 Radiated Emission Test Result

**Test Site** : DDT 3m Chamber 1# **D:\2025 RE 1# Report data\Q25091711-2E\1010 RE-H.EM6**  
**Test Date** : 2025-10-11 **Tested By** : Li guilin  
**Power Supply** : AC 240V/50Hz **Test Mode** : Charging + Bluetooth mode  
**Condition** : Temp:19.2°C, Humi:60.9% **Antenna/Distance** : 2025 9120D 1#/3m/  
VERTICAL  
**Memo** : S25091711-003

Data: 76

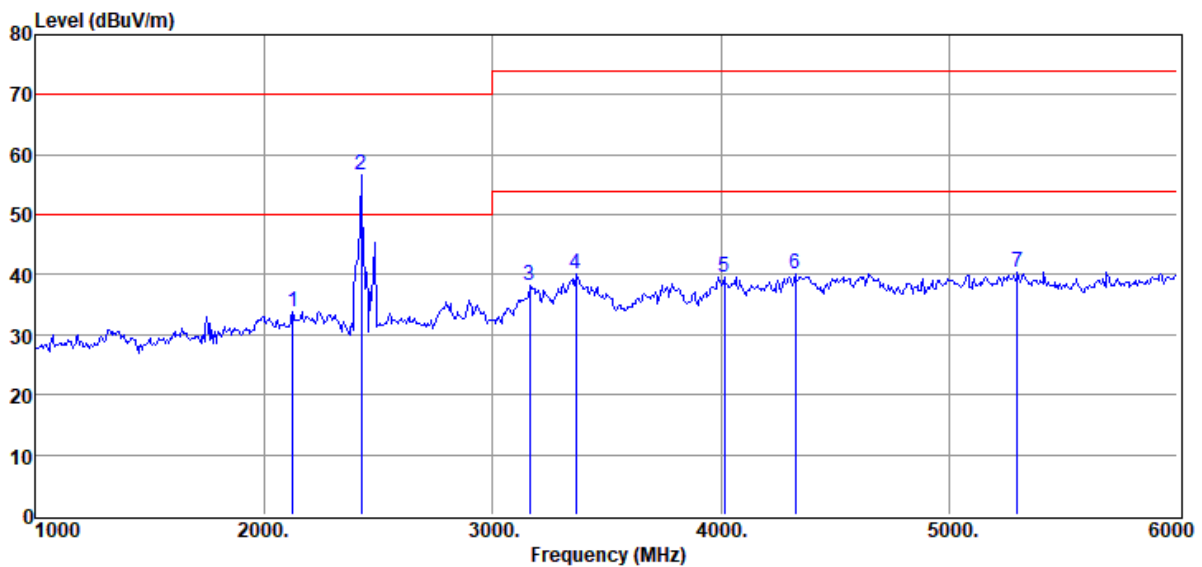

Item (Mark)	Freq. (MHz)	Read Level (dBuV)	Antenna Factor (dB/m)	PRM Factor dB	Cable Loss dB	Result Level (dBuV/m)	Limit Line (dBuV/m)	Margin (dB)	Detector	Polarization
1	2125.00	54.87	27.20	53.09	4.91	33.89	70.00	36.11	Peak	VERTICAL
2	2425.00	76.70	27.70	53.06	5.16	56.50	Carrier frequency		Peak	VERTICAL
3	3165.00	56.93	28.56	53.10	5.78	38.17	74.00	35.83	Peak	VERTICAL
4	3365.00	58.38	28.89	53.22	5.95	40.00	74.00	34.00	Peak	VERTICAL
5	4015.00	56.85	29.93	53.59	6.53	39.72	74.00	34.28	Peak	VERTICAL
6	4325.00	56.73	30.30	53.47	6.68	40.24	74.00	33.76	Peak	VERTICAL
7	5300.00	54.13	32.60	53.59	7.21	40.35	74.00	33.65	Peak	VERTICAL

Note: 1. Result Level = Read Level + Antenna Factor + Cable loss - PRM Factor.

2. If Peak Result complies with AV limit, AV Result is deemed to comply with AV limit.

3. Test setup: RBW: 1 MHz, VBW: 3 MHz, Sweep time: auto.

4. According to standard requirements, the radio carrier and harmonic frequencies of the samples are not included in the test results.

#### 4.8. Test photo

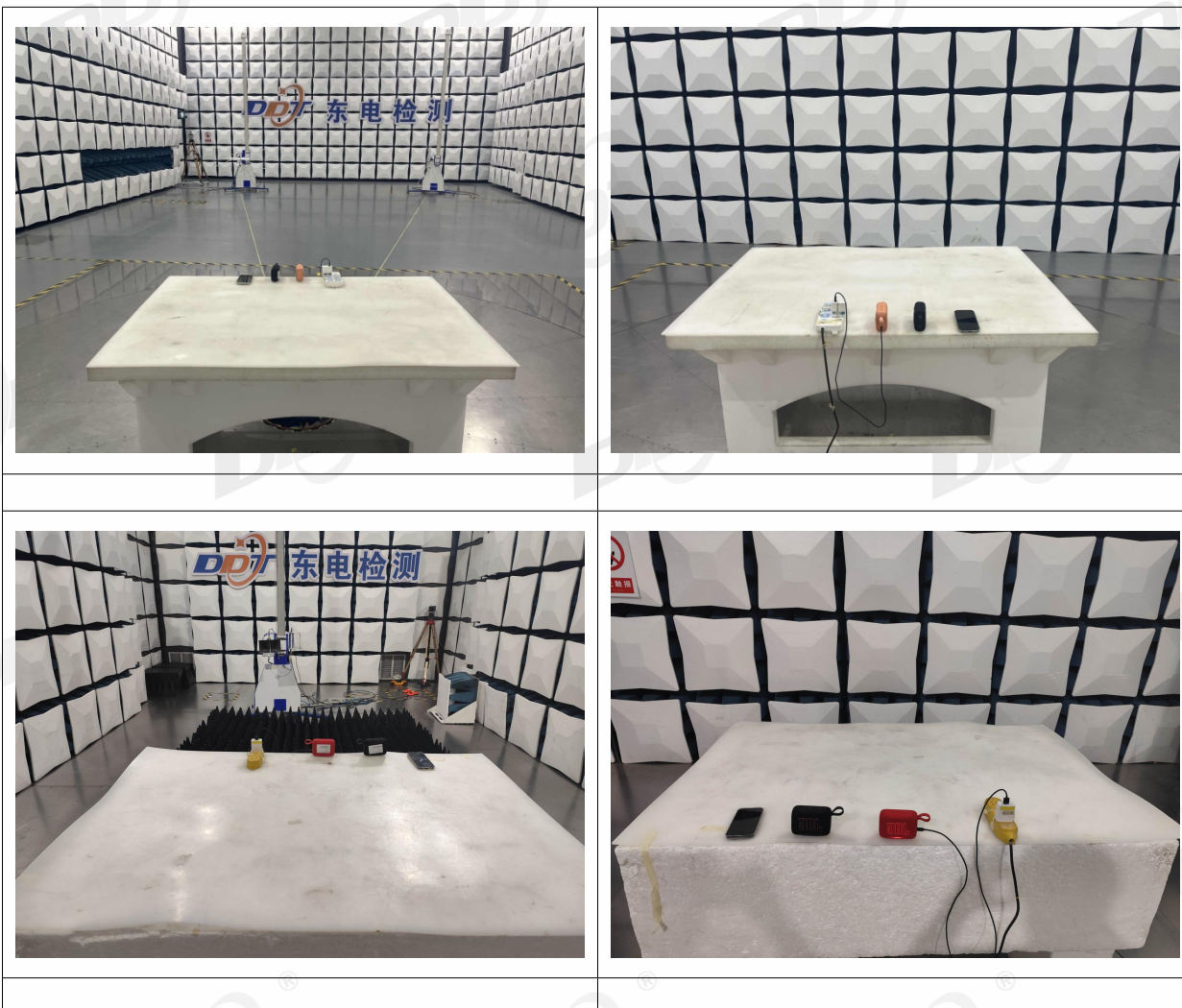

## 5. Voltage Fluctuations& Flicker Test

### 5.1. Test equipment

Equipment	Manufacturer	Model No.	Equipment No.	Cal. Due to
Harmonics&Flicker Analyzer	emtest	DPA503N	DDT-ZC04145	2025/10/29
Flicker impedance	AMETEK CTS	AIF 503N32.4	DDT-ZC04558	2025/10/29
NET.CONTROL	EM TEST	N/A	DDT-ZC00795	/
Electronic Power Source	emtest	NetWave 20-400	DDT-ZC04144	2026/03/28

### 5.2. Block diagram of test setup

Table-top device

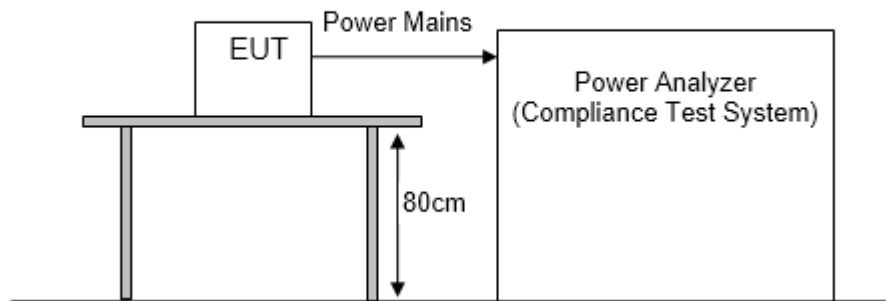

Floor-standing device

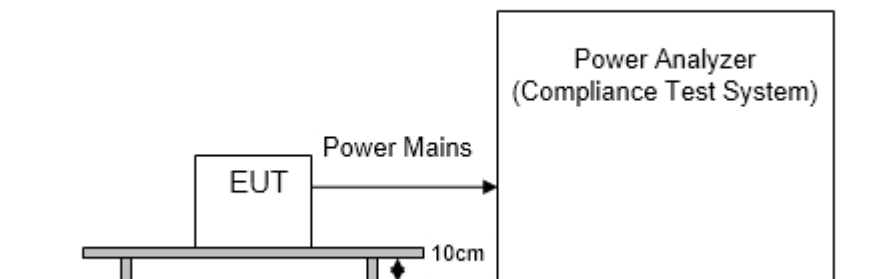

### 5.3. Test levels and performance criterion

Voltage fluctuations & flicker Limit

Test Item	Limit	Note
Pst	1.0	Pst means Short-term flicker indicator
Plt	0.65	Plt means long-term flicker indicator
Tdt	0.5	Tdt means maximum time that dt exceeds 3.3%
dmax (%)	4%	dmax means maximum relative voltage change.
dc (%)	3.3%	dc means relative steady-state voltage change.

#### 5.4. Assistant equipment used for test

Assistant equipment	Manufacturer	Model number	Description	other
Adapter	HUAWEI	HW-100400C01	Huawei fast charging 66W-1#/2# site	Input: 100-240V~ 50/60Hz, Output: 5V/2A or 9V/2A or 10V/4A MAX
Mobile Phone	HUAWEI	HMA-AL00	Huawei Phone-Mate 20	EMS site
USB cable	N/A	N/A	Length: 1m	N/A
PORTABLE BLUETOOTH SPEAKER	Harman	GO5D	N/A	N/A

#### 5.5. Test procedure

The EUT is placed on top of a wooden table (according to the standard height requirements, refer to the test layout), the most unfavorable sequence of voltage changes under normal conditions during the flick measurement; the measure time shall include that part of whole operation changes. The observation period for short-term flicker indicator is 10 minutes and the observation period for long-term flicker indicator is 2 hours.

#### 5.6. Test result

**Pass.** (See below detailed test result)

## 5.7. Test data

Test Report	
Test Object :	PORTABLE BLUETOOTH SPEAKER
Test Standard :	IEC 61000-3-3 (Ed3-2) - General Test conditions (230V - 50Hz)
Tester :	Bote Huang
Company :	Guangdong Dongdian Testing Service Co., Ltd.
Test Date :	9/30/2025 10:46:38 AM

Result	
E.U.T. :	PASS

Test Object / Product			
Name :	PORTABLE BLUETOOTH SPEAKER	Operation Mode :	Charging + Bluetooth mode
Serial Number :	S25091711-003	Connection :	/
Description :	GO5D		

Climatic Conditions			
Temperature :	22 °C	Pressure :	101 kPa
		Humidity :	45 %

Flicker Results	
Standard Specific Results for IEC 61000-3-3 (Edition 3.2)	

Standard Group: Industry

Standard Name: IEC 61000-3-3 (Edition 3.2)  
 Limitation of voltage changes, voltage fluctuations and flicker  
 in public low-voltage supply systems, for equipment with rated current ≤ 16 A per  
 phase  
 and not subject to conditional connection

Test Condition: General Test Conditions

Analysis Status: **PASS**

Flicker Measurements Settings	
Main Line:	230V, 50Hz
Flicker Meter:	230V / 50Hz
Flicker Impedance:	Zref
Observation Time:	1 × 10 min
Measurements:	1

Flicker Measurements						
	Last V <sub>rms</sub> [V]	P <sub>It</sub>	Max P <sub>st</sub>	Max d <sub>c</sub> [%]	Max d <sub>max</sub> [%]	Max T <sub>max</sub> [s]
Line 1:	230.846	0.033	0.076	0	< 0.2	0
Limits:		0.65	1	3.3	4	0.5
Results:		PASS	PASS	PASS	PASS	PASS

Flicker Individual Measurements												
Measurement	P <sub>st</sub> [ ]			d <sub>c</sub> [%]			d <sub>max</sub> [%]			T <sub>max</sub> [s]		
	Value	Limit	Result	Value	Limit	Result	Value	Limit	Result	Value	Limit	Result
#1	0.08	1.00	PASS	0.00	3.30	PASS	< 0.2	4.00	PASS	0.00	0.50	PASS

Pst Data										
Flicker (Line 1)										
Meas. No.	P0,1	P1s	P3s	P10s	P50s	Pst	dc [%]	dmax [%]	Tmax [s]	
1	0.016	0.014	0.013	0.011	0.007	0.076	0	0.116	0	



## Test Report

Test Object : PORTABLE BLUETOOTH SPEAKER  
 Test Standard : IEC 61000-3-3 (Ed3-2) - General Test conditions (230V - 50Hz)  
 Tester : Bote Huang  
 Company : Guangdong Dongdian Testing Service Co., Ltd.  
 Test Date : 10/23/2025 10:26:23 AM

### Result

E.U.T. : PASS

### Test Object / Product

Name :	PORTABLE BLUETOOTH SPEAKER	Operation Mode :	Charging + Bluetooth + TWS mode
Serial Number :	S25091711-003	Connection :	/
Description :	GO5D		

### Climatic Conditions

Temperature :	22 °C	Pressure :	101 kPa	Humidity :	45 %
---------------	-------	------------	---------	------------	------

### Flicker Results

Standard Specific Results for IEC 61000-3-3 (Edition 3.2)

Standard Group: Industry

Standard Name: IEC 61000-3-3 (Edition 3.2)  
 Limitation of voltage changes, voltage fluctuations and flicker  
 in public low-voltage supply systems, for equipment with rated current ≤ 16 A per  
 phase  
 and not subject to conditional connection

Test Condition: General Test Conditions

Analysis Status: **PASS**

Flicker Measurements Settings	
Main Line:	230V, 50Hz
Flicker Meter:	230V / 50Hz
Flicker Impedance:	Zref
Observation Time:	1 x 10 min
Measurements:	1

Flicker Measurements						
	Last $V_{rms}$ [V]	$P_{it}$	Max $P_{st}$	Max $d_c$ [%]	Max $d_{max}$ [%]	Max $T_{max}$ [s]
Line 1:	230.913	0.033	0.076	0	< 0.2	0
Limits:		0.65	1	3.3	4	0.5
Results:		PASS	PASS	PASS	PASS	PASS

Flicker Individual Measurements												
Measurement	$P_{st}$ [ ]			$d_c$ [%]			$d_{max}$ [%]			$T_{max}$ [s]		
	Value	Limit	Result	Value	Limit	Result	Value	Limit	Result	Value	Limit	Result
#1	0.08	1.00	PASS	0.00	3.30	PASS	< 0.2	4.00	PASS	0.00	0.50	PASS

Pst Data										
Flicker (Line 1)										
Meas. No.	P0,1	P1s	P3s	P10s	P50s	Pst	dc [%]	dmax [%]	Tmax [s]	
1	0.016	0.014	0.013	0.012	0.006	0.076	0	0.119	0	



5.8. Test photo

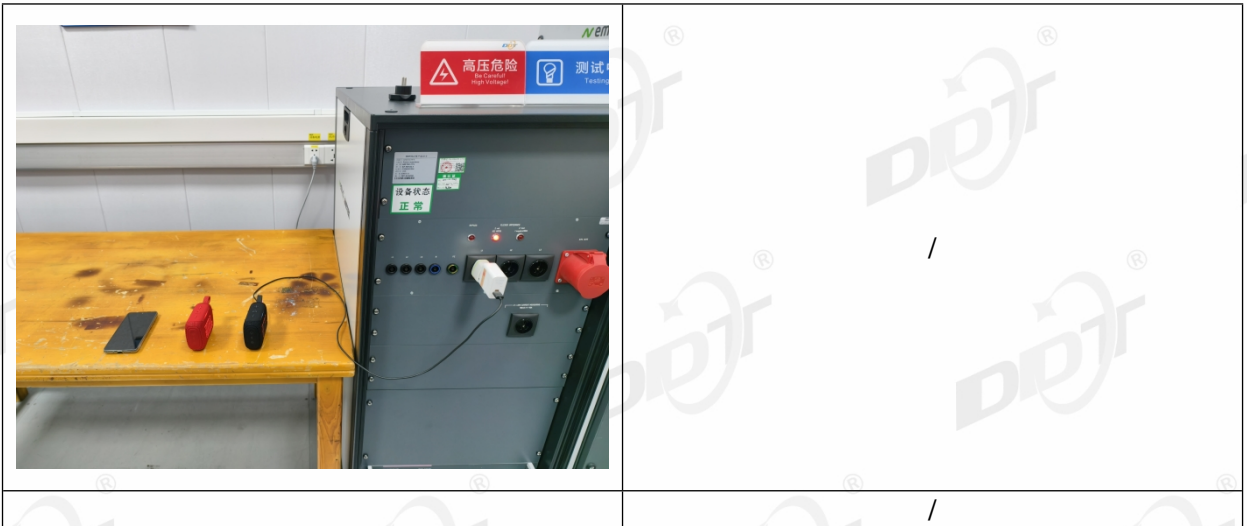

## 6. Electrostatic Discharge Test

### 6.1. Test equipment

Equipment	Manufacturer	Model No.	Equipment No.	Cal. Due to
ESD Generator	TESEQ	NSG 437	DDT-ZC01820	2026/04/01

### 6.2. Block diagram of test setup

Table-top equipment

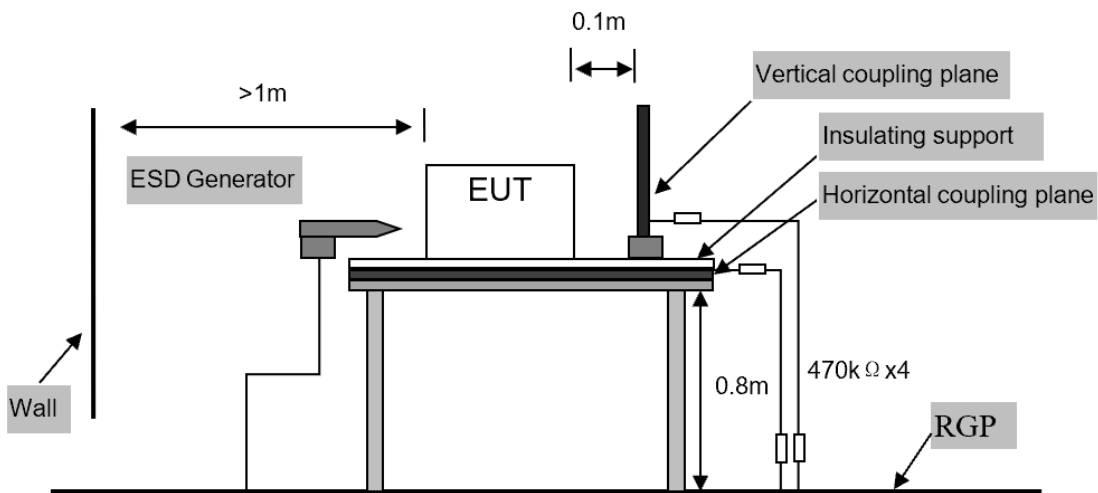

Floor-standing equipment

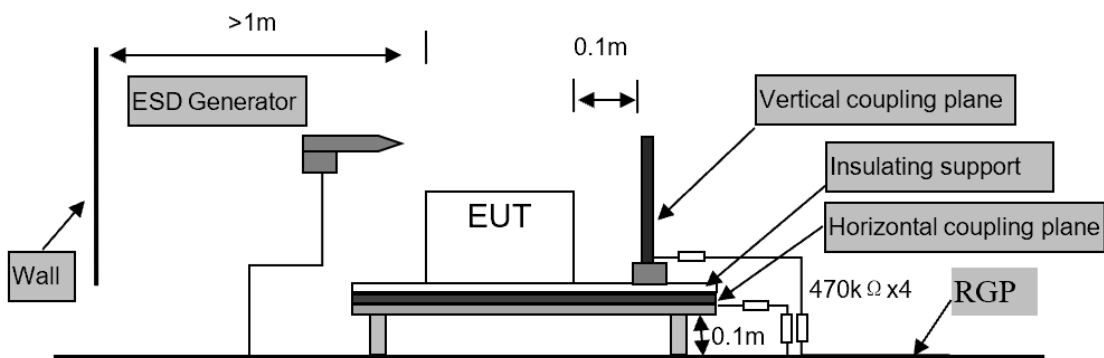

### 6.3. Test levels and performance criterion

Test Level		Performance Criteria
Air Discharge	±2kV, ±4kV and ±8kV	B
Contact Discharge	±4kV	

Performance criteria B description: During the test, degradation of performance is allowed. However, no change of operating state or stored data is allowed to persist after the test. After the

test, the EUT shall continue to operate as intended without operator intervention. No degradation of performance or loss of function is allowed, after the application of the phenomena below a performance level specified by the manufacturer, when the EUT is used as intended.

#### 6.4. Assistant equipment used for test

Assistant equipment	Manufacturer	Model number	Description	other
Adapter	HUAWEI	HW-100400C01	Huawei fast charging 66W-1#/2# site	Input: 100-240V~ 50/60Hz, Output: 5V/2A or 9V/2A or 10V/4A MAX
USB cable	N/A	N/A	Length: 1m	N/A
PORTABLE BLUETOOTH SPEAKER	Harman	GO5D	N/A	N/A
Mobile Phone	HUAWEI	HMA-AL00	Huawei Phone-Mate 20	N/A

#### 6.5. Test procedure

Air Discharge:

The test was applied on non-conductive surfaces of EUT. The round discharge tip of the discharge electrode was approached as fast as possible to touch the EUT. After each discharge, the discharge electrode was removed from the EUT. The generator was re-triggered for a new single discharge and repeated 20 times for each pre-selected test point. This procedure was repeated until all the air discharge completed.

Contact Discharge:

All the procedure was same as air discharge. Except that the generator was re-triggered for a new single discharge. The tip of the discharge electrode was touching the EUT before the discharge switch was operated.

Indirect discharge for horizontal coupling plane:

At least 20 single discharges were applied to the horizontal coupling plane, at points on each side of the EUT. The discharge electrode positions vertically at a distance of 0.1m from the EUT and with the discharge electrode touching the coupling plane.

Indirect discharge for vertical coupling plane:

At least 20 single discharges were applied to the center of one vertical edge of the coupling plane. The coupling plane, of dimensions 0.5m X 0.5m, was placed parallel to, and positioned at a distance of 0.1m from the EUT. Discharges were applied to the coupling plane, with this plane in sufficient different positions that the four faces of the EUT are completely illuminated.

## 6.6. Test result

Test Site: 7#EMC Shield Room	Test Date: 2025/10/16--2025/10/16
Condition: 24°C,45%RH,101kPa	Test Engineer: Elosky Liu
Memo: /	

EUT Name: PORTABLE BLUETOOTH SPEAKER		EUT Model: GO5D			
Sample No.: S25091711-003		Test Mode: Bluetooth mode			
Power supply: Battery		Memo:/			
Measure parameters: 20 times at each point for contact discharge; 20 times at each point for air discharge. 1 second interval for each discharge.					
Type of discharge	Test Level	Test Point	Required	Observation	Result
Contact to EUT	±4kV	5	B	A	Pass
Contact to Coupling Planes	±4kV	Coupling Planes	B	A	Pass
Air	±2 kV /±4 kV /±8kV	1,2,3,4,5	B	A	Pass
Observation Description: A: Normal performance within limits specified by the manufacturer requestor or purchaser.					

EUT Name: PORTABLE BLUETOOTH SPEAKER		EUT Model: GO5D			
Sample No.: S25091711-003		Test Mode: Charging + Bluetooth + TWS mode			
Power supply: AC 230V/50Hz		Memo:/			
Measure parameters: 20 times at each point for contact discharge; 20 times at each point for air discharge. 1 second interval for each discharge.					
Type of discharge	Test Level	Test Point	Required	Observation	Result
Contact to EUT	±4kV	/	B	/	/
Contact to Coupling Planes	±4kV	Coupling Planes	B	A	Pass
Air	±2 kV /±4 kV /±8kV	1,2,3,4,5	B	A	Pass
Observation Description: A: Normal performance within limits specified by the manufacturer requestor or purchaser.					

EUT Name: PORTABLE BLUETOOTH SPEAKER			EUT Model: GO5D		
Sample No.: S25091711-003			Test Mode: Charging + Bluetooth mode		
Power supply: AC 230V/50Hz			Memo: /		
Measure parameters: 20 times at each point for contact discharge; 20 times at each point for air discharge. 1 second interval for each discharge.					
Type of discharge	Test Level	Test Point	Required	Observation	Result
Contact to EUT	±4kV	/	B	/	/
Contact to Coupling Planes	±4kV	Coupling Planes	B	A	Pass
Air	±2 kV /±4 kV /±8kV	1,2,3,4,5	B	A	Pass
Observation Description: A: Normal performance within limits specified by the manufacturer requestor or purchaser.					

EUT Name: PORTABLE BLUETOOTH SPEAKER			EUT Model: GO5D		
Sample No.: S25091711-003			Test Mode: Bluetooth + TWS mode		
Power supply: Battery			Memo: /		
Measure parameters: 20 times at each point for contact discharge; 20 times at each point for air discharge. 1 second interval for each discharge.					
Type of discharge	Test Level	Test Point	Required	Observation	Result
Contact to EUT	±4kV	5	B	A	Pass
Contact to Coupling Planes	±4kV	Coupling Planes	B	A	Pass
Air	±2 kV /±4 kV /±8kV	1,2,3,4,5	B	A	Pass
Observation Description: A: Normal performance within limits specified by the manufacturer requestor or purchaser.					

### 6.7. ESD test points



### 6.8. Test photo

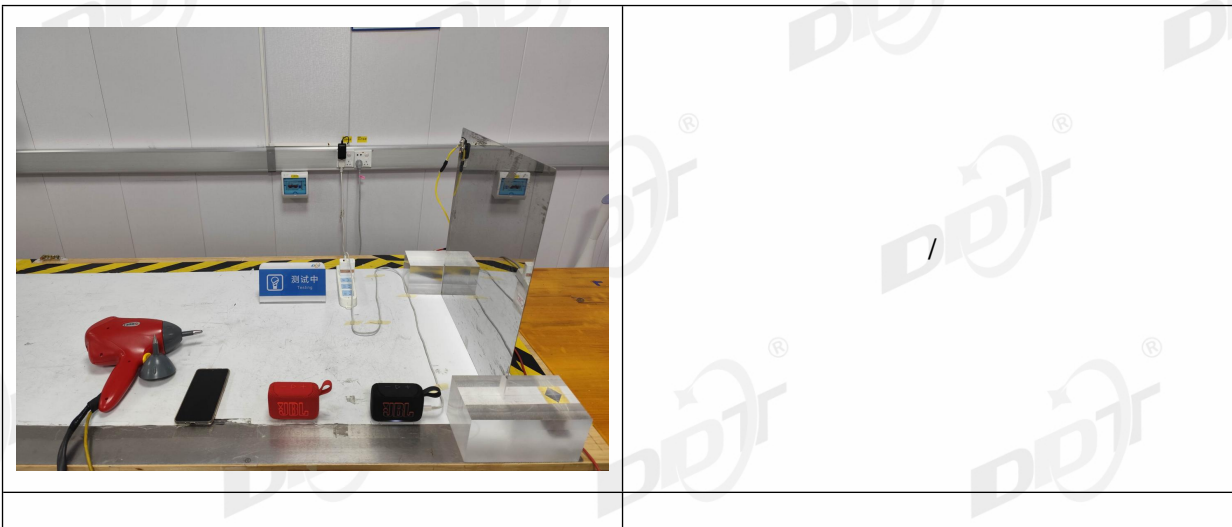

## 7. Continuous Radio Frequency Disturbances Test

### 7.1. Test equipment

Equipment	Manufacturer	Model No.	Equipment No.	Cal. Due to
MXG Vector Signal Generator	Agilent	N5182A	DDT-ZC00239	2026/07/06
Power meter	Agilent	E4417A	DDT-ZC00934	2026/07/06
Power sensor	Agilent	E9323A	DDT-ZC00938	2026/08/10
Power sensor	Agilent	E9323A	DDT-ZC00939	2026/08/10
Electric Field Sensors	DARE Instruments	CTR1001S	DDT-ZC02865	2025/11/03
Power Amplifier	Wonder	HPA80M1000M500	DDT-ZC00940	2026/07/06
Power Amplifier	Wonder	HPA1000M2500M300	DDT-ZC00941	2026/07/06
Power Amplifier	Wonder	HPA2500M6000M200	DDT-ZC00942	2026/07/06
RS Test Software	SKET	EMC-S	DDT-ZC01455	/
Log-Periodic Antenna	schwarzbeck	STLP 9129	DDT-ZC04673	2025/11/24

### 7.2. Block diagram of test setup

Table-top device

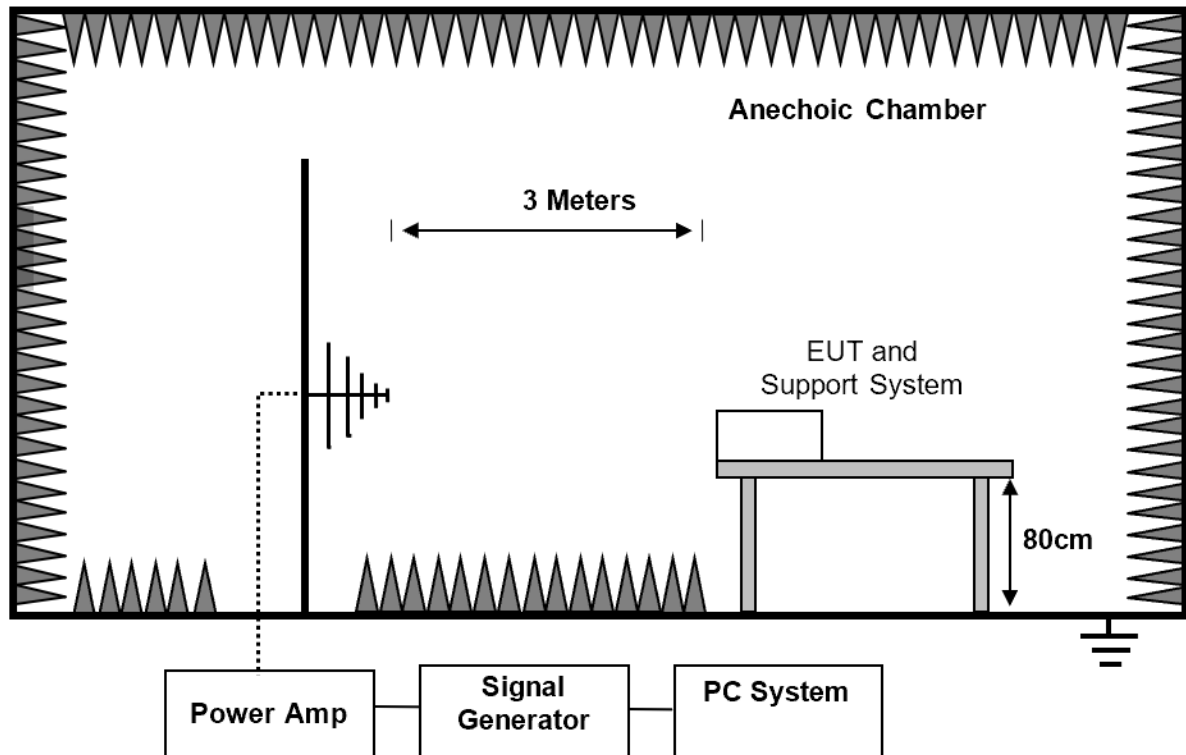

Floor-standing device

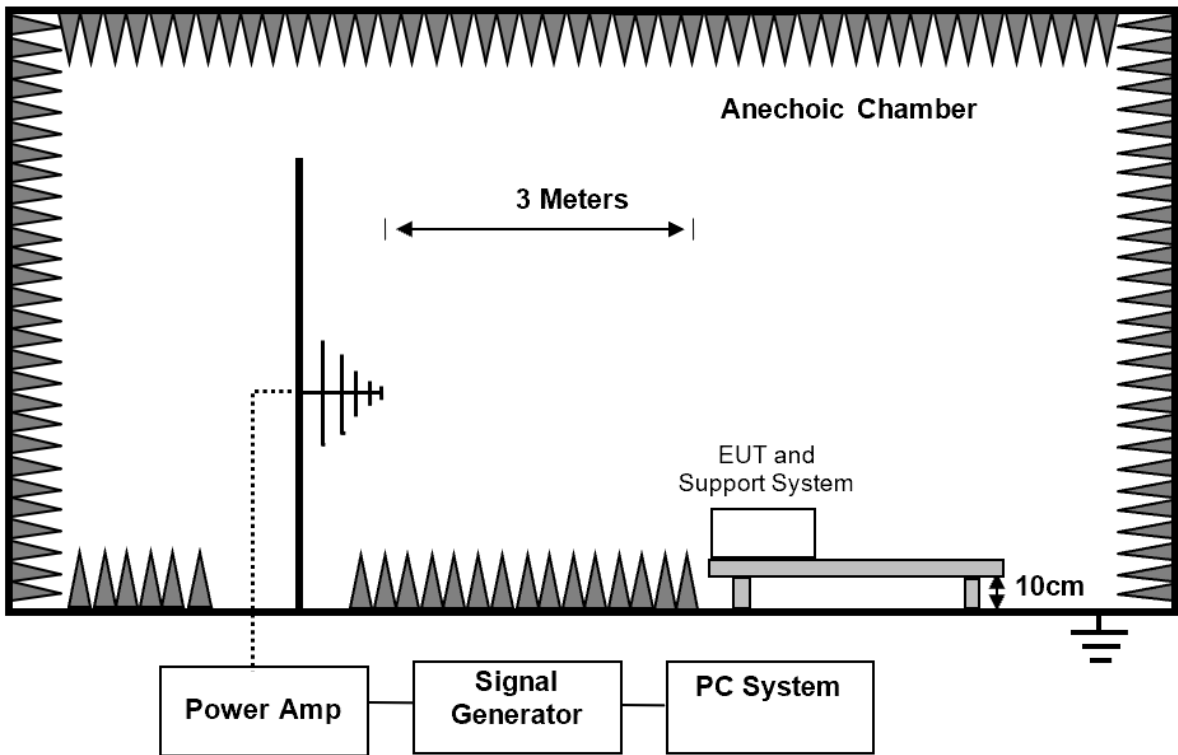

7.3. Test levels and performance criterion

Test Level		Performance Criteria
Frequency	80 MHz to 6 GHz	A
Field Strength	3V/m measured unmodulated	
Modulation	AM modulated to a depth of 80% by a sinusoidal audio signal of □ 1 kHz/⊠ 400 Hz	
Step Size	1% increments	
Dwell time	>0.5 Sec.	

#### 7.4. Assistant equipment used for test

Assistant equipment	Manufacturer	Model number	Description	other
Adapter	HUAWEI	HW-100400C01	Huawei fast charging 66W-1#/2# site	Input: 100-240V~ 50/60Hz, Output: 5V/2A or 9V/2A or 10V/4A MAX
USB cable	N/A	N/A	Length: 1m	N/A
PORTABLE BLUETOOTH SPEAKER	Harman	GO5D	N/A	N/A
Mobile Phone	HUAWEI	HMA-AL00	Huawei Phone-Mate 20	N/A

#### 7.5. Test procedure

The field sensor is placed on the EUT table (Ground clearance height reference "block diagram of test setup") which is 3 meters away from the transmitting antenna. Through the signal generator, power amplifier and transmitting antenna to produce a uniformity field strength around the EUT table from frequency range specified and records the signal generator 's output level at the same time for whole measured frequency range. Then, put EUT and its simulators on the EUT turn table and keep them 3 meters away from the transmitting antenna which is mounted on an antenna tower and fixes at 1 meter height above the ground. Using the recorded signal generator's output level to measure the EUT from frequency range specified and both horizontal & vertical polarization of antenna must be set and measured. Each of the four sides of EUT must be faced this transmitting antenna and measures individually.

## 7.6. Test result

Test Site: 4# 1m Chamber	Test Date: 2025/10/11--2025/10/11
Condition: 21°C,45%RH	Test Engineer: Huang Shaotao
Memo: /	

EUT Name: PORTABLE BLUETOOTH SPEAKER	EUT Model: GO5D
Sample No.: S25091711-003	Test Mode: Bluetooth + TWS mode
Power supply: Battery	Memo: /

Steps: 1%, Dwell time 1s, 0.4kHz 80% AM modulation

Test frequency	Level	EUT Position	Antenna Polarization	Required	Observation	Result
80MHz to 6000MHz	3V/m	Front	H	A	A	Pass
			V	A	A	Pass
		Left	H	A	A	Pass
			V	A	A	Pass
		Rear	H	A	A	Pass
			V	A	A	Pass
		Right	H	A	A	Pass
			V	A	A	Pass

Observation Description:

A: Normal performance within limits specified by the manufacturer requestor or purchaser.

EUT Name: PORTABLE BLUETOOTH SPEAKER	EUT Model: GO5D
Sample No.: S25091711-003	Test Mode: Bluetooth mode
Power supply: Battery	Memo: /

Steps: 1%, Dwell time 1s,0.4kHz 80% AM modulation

Test frequency	Level	EUT Position	Antenna Polarization	Required	Observation	Result
80MHz to 6000MHz	3V/m	Front	H	A	A	Pass
			V	A	A	Pass
		Left	H	A	A	Pass
			V	A	A	Pass
		Rear	H	A	A	Pass
			V	A	A	Pass
		Right	H	A	A	Pass
			V	A	A	Pass

Observation Description:

A: Normal performance within limits specified by the manufacturer requestor or purchaser.

EUT Name: PORTABLE BLUETOOTH SPEAKER	EUT Model: GO5D
Sample No.: S25091711-003	Test Mode: Charging + Bluetooth mode
Power supply: AC 230V/50Hz	Memo: /

Steps: 1%, Dwell time 1s, 0.4kHz 80% AM modulation

Test frequency	Level	EUT Position	Antenna Polarization	Required	Observation	Result
80MHz to 6000MHz	3V/m	Front	H	A	A	Pass
			V	A	A	Pass
		Left	H	A	A	Pass
			V	A	A	Pass
		Rear	H	A	A	Pass
			V	A	A	Pass
		Right	H	A	A	Pass
			V	A	A	Pass

Observation Description:

A: Normal performance within limits specified by the manufacturer requestor or purchaser.

EUT Name: PORTABLE BLUETOOTH SPEAKER	EUT Model: GO5D
Sample No.: S25091711-003	Test Mode: Charging + Bluetooth + TWS mode
Power supply: AC 230V/50Hz	Memo: /

Steps: 1%, Dwell time 1s, 0.4kHz 80% AM modulation

Test frequency	Level	EUT Position	Antenna Polarization	Required	Observation	Result
80MHz to 6000MHz	3V/m	Front	H	A	A	Pass
			V	A	A	Pass
		Left	H	A	A	Pass
			V	A	A	Pass
		Rear	H	A	A	Pass
			V	A	A	Pass
		Right	H	A	A	Pass
			V	A	A	Pass

Observation Description:

A: Normal performance within limits specified by the manufacturer requestor or purchaser.

### 7.7. Test photo

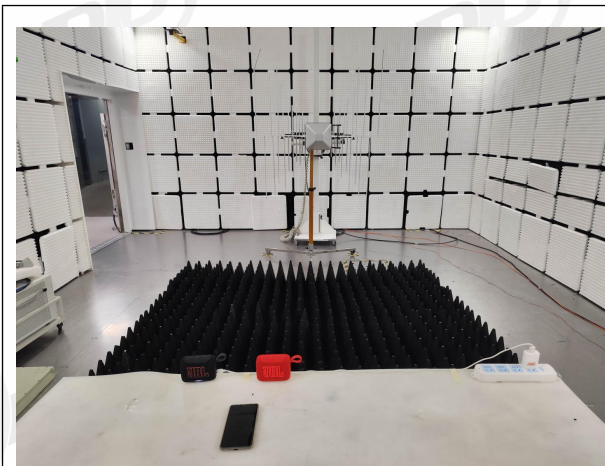

## 8. Electrical Fast Transients(EFT) Test

### 8.1. Test equipment

Equipment	Manufacturer	Model No.	Equipment No.	Cal. Due to
EFT Generator	EMC Partner	TRA3000F	DDT-ZC00546	2026/03/28
Coupling Clamp EFT	EMC Partner	CN-EFT1000	DDT-ZC00547	2026/03/28

### 8.2. Block diagram of test setup

For power port (Note: if the DC network power cable may be lengths greater than 3 m, the requirement is applicable).

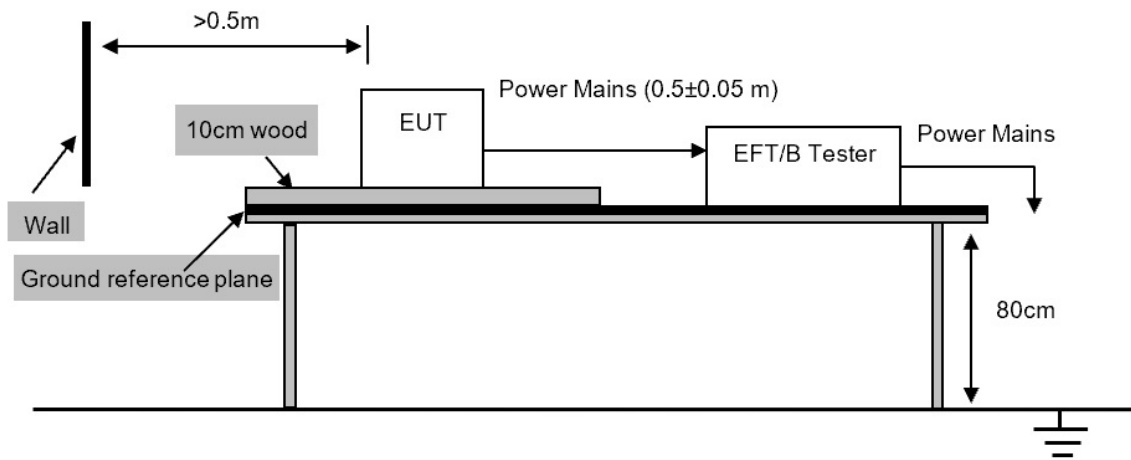

For analogue/digital data ports, if the cables may be longer than 3 m.

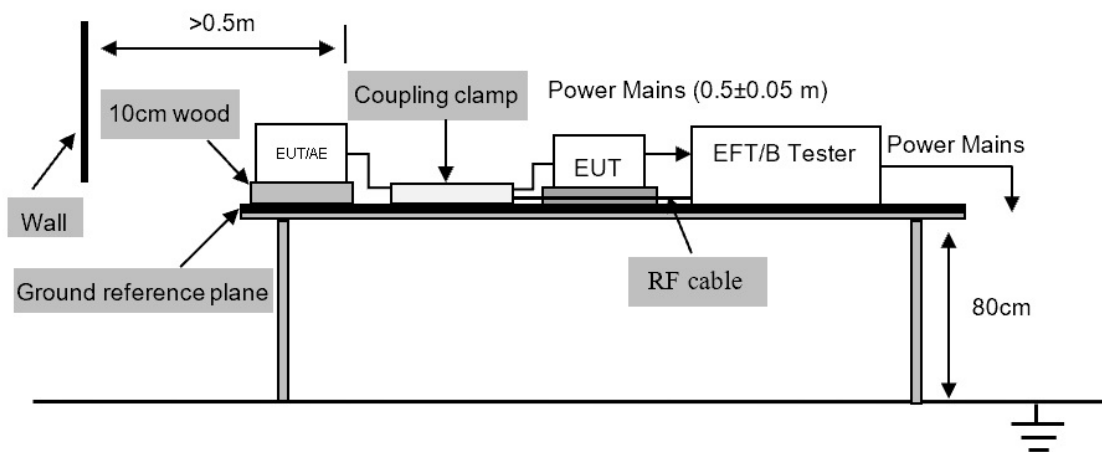

### 8.3. Test levels and performance criterion

Test Level			Performance Criteria
Test voltage	±1kV For AC mains Port	±0.5kV for dc input or signal Port	B
Repetition Frequency	5kHz	5kHz	
Burst Duration	15ms	15ms	
Burst Period	300ms	300ms	
Inject Time(s)	120s	120s	
Inject Method	Direct for AC mains port	Capacitive coupling clamp or CDN	
Inject Line	AC mains	signal ports, wired network ports, control ports, and DC power ports	

Note: This test shall be additionally performed on signal ports, wired network ports, control ports, and DC power ports, of radio equipment and associated ancillary equipment, if the cables may be longer than 3 m.

Performance criteria B description: During the test, degradation of performance is allowed. However, no change of operating state or stored data is allowed to persist after the test. After the test, the EUT shall continue to operate as intended without operator intervention. No degradation of performance or loss of function is allowed, after the application of the phenomena below a performance level specified by the manufacturer, when the EUT is used as intended.

### 8.4. Assistant equipment used for test

Assistant equipment	Manufacturer	Model number	Description	other
Adapter	HUAWEI	HW-100400C01	Huawei fast charging 66W-1#/2# site	Input: 100-240V~ 50/60Hz, Output: 5V/2A or 9V/2A or 10V/4A MAX
USB cable	N/A	N/A	Length: 1m	N/A
PORTABLE BLUETOOTH SPEAKER	Harman	GO5D	N/A	N/A
Mobile Phone	HUAWEI	HMA-AL00	Huawei Phone-Mate 20	N/A

### 8.5. Test procedure

The EUT and its simulators were placed on the ground reference plane and were insulated from it by a wood support 0.1m ± 0.01m thick. The ground reference plane was 1m\*1m metallic sheet with 0.65mm minimum thickness. This reference ground plane was project beyond the EUT by at least 0.1m on all sides and the minimum distance between EUT and all other conductive structure, except the ground plane was more than 0.5m. All cables to the EUT was placed on the wood support, cables not subject to EFT/B was routed as far as possible from the cable under test to minimize the coupling between the cables.

For DC power port and AC main ports:

The EUT was connected to the power mains by using a coupling device that couples the EFT interference signal to AC or DC power lines. Both positive transients and negative transients of test voltage were applied during compliance test and the duration of the test can't less than 2mins.

For signal ports, wired network ports, control ports:

The capacitive coupling clamp was connected to the power by using a coupling device that couples the EFT interference signal to capacitive coupling clamp. Both positive transients and negative transients of test voltage were applied during compliance test and the duration of the test can't less than 2mins.

## 8.6. Test result

Test Site: 7#EMC Shield Room	Test Date: 2025/10/09--2025/10/09
Condition: 22°C,45%RH	Test Engineer: Hans Xu
Memo: /	

EUT Name: PORTABLE BLUETOOTH SPEAKER	EUT Model: GO5D
Sample No.: S25091711-003	Test Mode: Charging + Bluetooth mode
Power supply: AC 230V/50Hz	Memo: /

Test Burst parameters: Burst Period 300ms, Durations 15ms, Repetition Frequency 5kHz

Port/ Coupling	Line	Test Voltage	Test time(s)	Required	Observation	Result
AC Mains/ Direct	L	+1kV	120	B	A	Pass
		-1kV	120	B	A	Pass
	N	+1kV	120	B	A	Pass
		-1kV	120	B	A	Pass
	L-N	+1kV	120	B	A	Pass
		-1kV	120	B	A	Pass

Observation Description:

A: Normal performance within limits specified by the manufacturer requestor or purchaser.

EUT Name: PORTABLE BLUETOOTH SPEAKER				EUT Model: GO5D		
Sample No.: S25091711-003				Test Mode: Charging + Bluetooth + TWS mode		
Power supply: AC 230V/50Hz				Memo: /		
Test Burst parameters: Burst Period 300ms, Durations 15ms, Repetition Frequency 5kHz						
Port/ Coupling	Line	Test Voltage	Test time(s)	Required	Observation	Result
AC Mains/ Direct	L	+1kV	120	B	A	Pass
		-1kV	120	B	A	Pass
	N	+1kV	120	B	A	Pass
		-1kV	120	B	A	Pass
	L-N	+1kV	120	B	A	Pass
		-1kV	120	B	A	Pass
Observation Description: A: Normal performance within limits specified by the manufacturer requestor or purchaser.						

8.7. Test photo

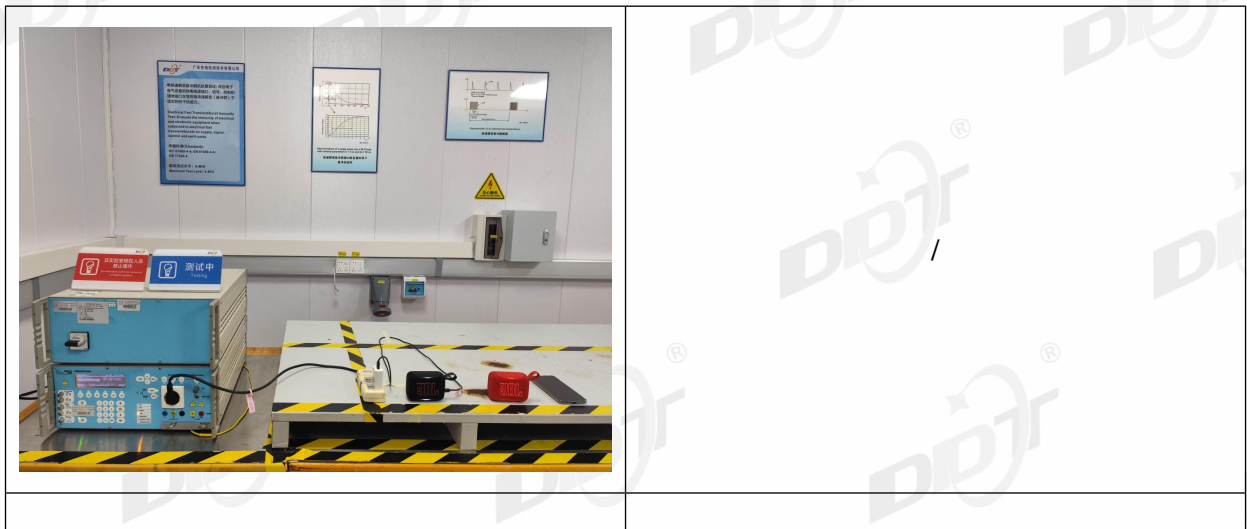

## 9. Surge Test

### 9.1. Test equipment

Equipment	Manufacturer	Model No.	Equipment No.	Cal. Due to
SURGE Generator	EMC Partner	TRANSIENT200 0	DDT-ZC00544	2026/03/28

### 9.2. Block diagram of test setup

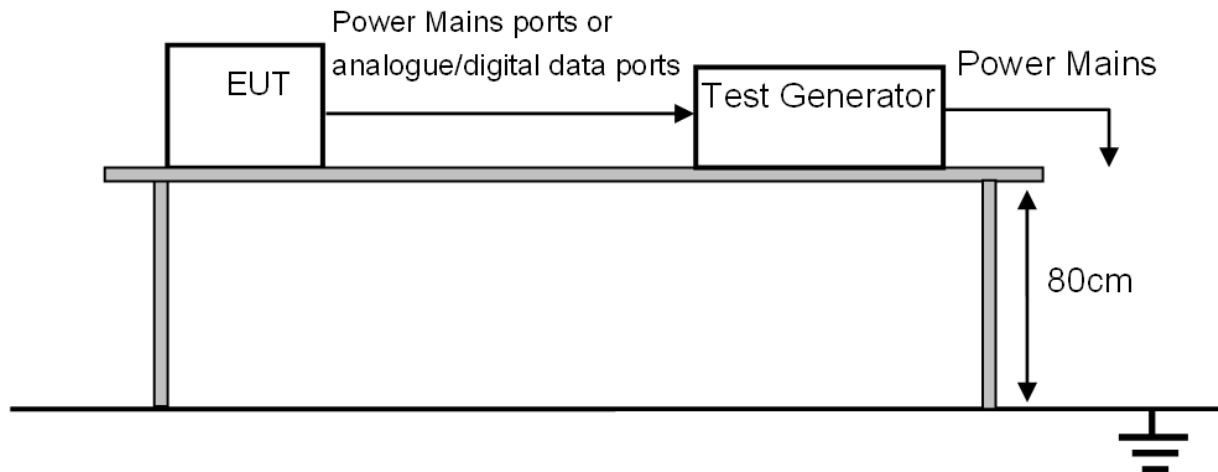

### 9.3. Test levels and performance criterion

Test level for AC mains ports		Performance Criterion
Line to Line	1 kV 1.2/50(8/20) $\mu$ s	B
Line to Ground	2 kV 1.2/50(8/20) $\mu$ s	B
Note: In telecom centres 1 kV line to ground and 0,5 kV line to line shall be used.		
Wired network port (outdoor)		Performance Criterion
Line to Ground	1 kV 10/700(5/320) $\mu$ s (symmetrically)	B
Line to Ground or Shield to Ground	1 kV 1.2/50(8/20) $\mu$ s (non-symmetrically)	B
Line to Line	0.5 kV 1.2/50(8/20) $\mu$ s (non-symmetrically)	B
Wired network port (indoor)		Performance Criterion
Line to Ground or Shield to Ground	0.5 kV 1.2/50(8/20) $\mu$ s (longer than 30m)	B

Performance criteria B description: During the test, degradation of performance is allowed. However, no change of operating state or stored data is allowed to persist after the test. After the test, the EUT shall continue to operate as intended without operator intervention. No degradation of performance or loss of function is allowed, after the application of the phenomena below a performance level specified by the manufacturer, when the EUT is used as intended.

#### 9.4. Assistant equipment used for test

Assistant equipment	Manufacturer	Model number	Description	other
Adapter	HUAWEI	HW-100400C01	Huawei fast charging 66W-1#/2# site	Input: 100-240V~ 50/60Hz, Output: 5V/2A or 9V/2A or 10V/4A MAX
USB cable	N/A	N/A	Length: 1m	N/A
PORTABLE BLUETOOTH SPEAKER	Harman	GO5D	N/A	N/A
Mobile Phone	HUAWEI	HMA-AL00	Huawei Phone-Mate 20	N/A

#### 9.5. Test procedure

For line-to- nature coupling mode, provide a 1 kV 1.2/50 us voltage surge (at pen-circuit condition) and 8/20 us current surge to EUT selected points.

For line-to- ground coupling mode, provide a 2 kV 1.2/50 us voltage surge (at pen-circuit condition) and 8/20 us current surge to EUT selected points.

At least 5 positive and 5 negative (polarity) tests with a maximum 1-minute repetition rate are applied during test.

Different phase angles are done individually.

For other surge test, each line of internet port to ground coupling mode, provide a combination wave specified above table.

At least 5 positive and 5 negative (polarity) tests with a maximum 1-minute repetition rate are applied during test.

Record the EUT operating situation during compliance test and decide the EUT immunity criterion for above each test.

## 9.6. Test result

Test Site: 1# Surge Room	Test Date: 2025/10/13--2025/10/13
Condition: 26°C,49%RH	Test Engineer: Bote Huang
Memo: /	

EUT Name: PORTABLE BLUETOOTH SPEAKER	EUT Model: GO5D
Sample No.: S25091711-003	Test Mode: Charging + Bluetooth + TWS mode
Power supply: AC 230V/50Hz	Memo: /

Test wave parameters: Wave Type: 1.2/50us-8/20us; Voltage Phase: 0°, 90°, 180°, 270°; Pulse times: 5 times at each polarity; Pulse Interval: 60s

Line/Port	Internal impedance	Test Voltage	Required	Observation	Result
L-N	2Ω	+0.5kV	B	A	Pass
	2Ω	-0.5kV	B	A	Pass
L-N	2Ω	+1kV	B	A	Pass
	2Ω	-1kV	B	A	Pass

Observation Description:

A: Normal performance within limits specified by the manufacturer requestor or purchaser.

EUT Name: PORTABLE BLUETOOTH SPEAKER	EUT Model: GO5D
Sample No.: S25091711-003	Test Mode: Charging + Bluetooth mode
Power supply: AC 230V/50Hz	Memo: /

Test wave parameters: Wave Type: 1.2/50us-8/20us; Voltage Phase: 0°, 90°, 180°, 270°; Pulse times: 5 times at each polarity; Pulse Interval: 60s

Line/Port	Internal impedance	Test Voltage	Required	Observation	Result
L-N	2Ω	+0.5kV	B	A	Pass
	2Ω	-0.5kV	B	A	Pass
L-N	2Ω	+1kV	B	A	Pass
	2Ω	-1kV	B	A	Pass

Observation Description:

A: Normal performance within limits specified by the manufacturer requestor or purchaser.

### 9.7. Test photo

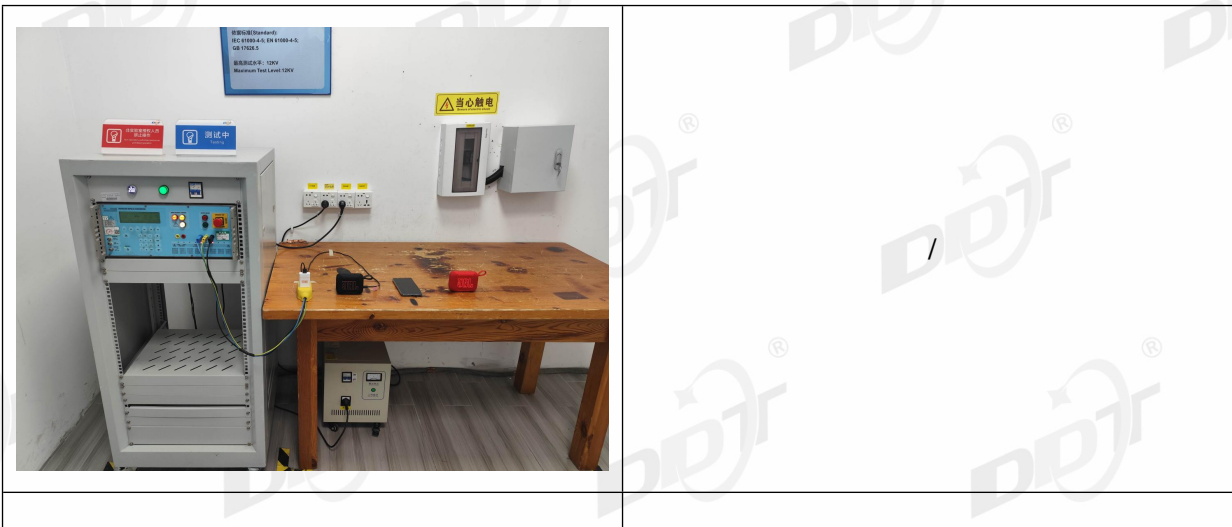

## 10. Continuous Conducted Disturbances Test

### 10.1. Test equipment

Equipment	Manufacturer	Model No.	Equipment No.	Cal. Due to
Conducted Immunity Tester	FRANKONIA	CIT-10	DDT-ZC00551	2026/03/28
CDN	SCHWARZBEC K	CDN M2/M3PE 16A	DDT-ZC01558	2026/07/06
Attenuation	BIRD	DAM75W (6dB)	DDT-ZC00555	2026/07/06
EM Clamp	FRANKONIA	EMCL	DDT-ZC00556	2026/08/10
CDN	SHANGHAI LIONCEL	CDN-M3-32	DDT-ZC01540	2026/07/06
Test Software	FRANKONIA	IEC/EN61000-4- 6	DDT-ZC00564	/
CS Test Software	SKET	EMC-S	DDT-ZC01429	/
CDN	FRANKONIA	CDNT8	DDT-ZC00553	2026/07/06

### 10.2. Block diagram of test setup

For power port (Note: if the DC network power cable may be lengths greater than 3 m, the requirement is applicable).

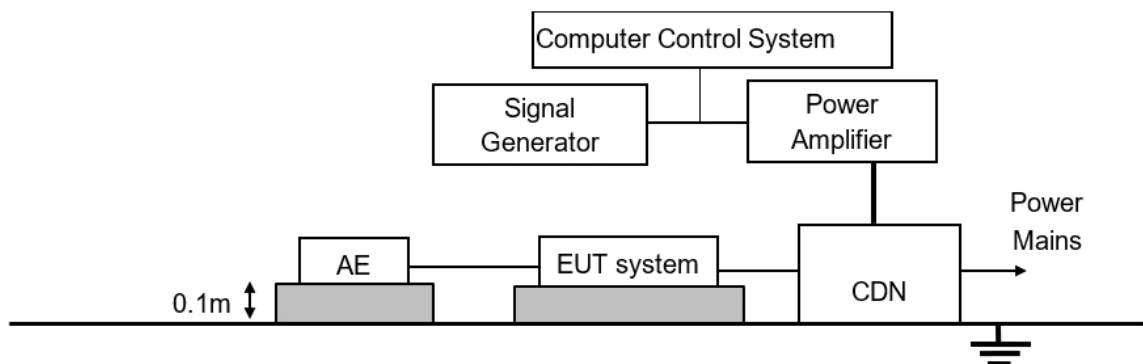

For signal/wired network/control ports, if the cables may be longer than 3 m.

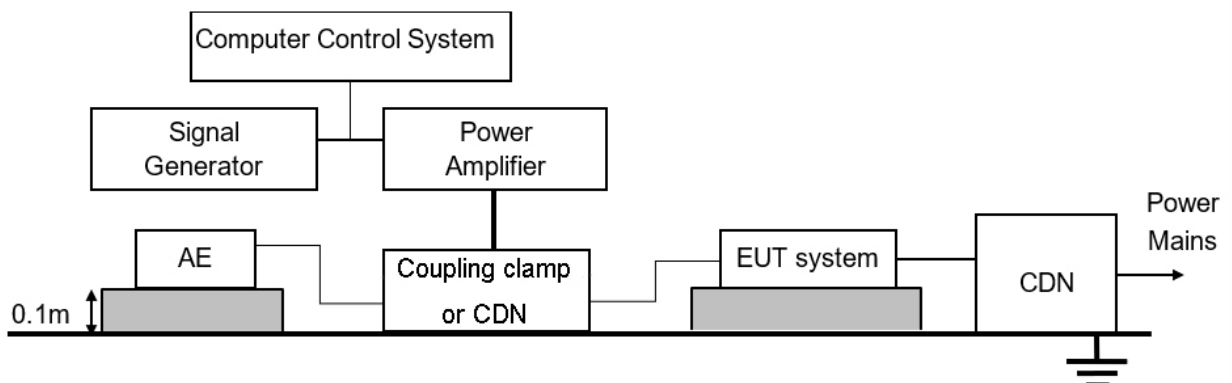

### 10.3. Test levels and performance criterion

Test Level		Performance Criteria
Frequency	0.15 MHz to 80 MHz	A
Field Strength	3V measured unmodulated	
Modulation	AM modulated to a depth of 80% by a sinusoidal audio signal of $\boxtimes$ 1 kHz / $\square$ 400 Hz (see note1)	
Step Size	1% increments	
Dwell time	>0.5 Sec.	

Note 1: If the wanted signal is modulated at 1 kHz, then the test signal of 400 Hz shall be used.  
Note 2: This test shall be additionally performed on signal ports, wired network ports, control ports, and DC power ports, of radio equipment and associated ancillary equipment, if the cables may be longer than 3 m.

### 10.4. Assistant equipment used for test

Assistant equipment	Manufacturer	Model number	Description	other
Adapter	HUAWEI	HW-100400C01	Huawei fast charging 66W-1#/2# site	Input: 100-240V~ 50/60Hz, Output: 5V/2A or 9V/2A or 10V/4A MAX
USB cable	N/A	N/A	Length: 1m	N/A
PORTABLE BLUETOOTH SPEAKER	Harman	GO5D	N/A	N/A
Mobile Phone	HUAWEI	HMA-AL00	Huawei Phone-Mate 20	N/A

### 10.5. Test procedure

The EUT are placed on an insulating support 0.1m high above a ground reference plane. CDN (coupling and decoupling device) is placed on the ground plane about 0.3m from EUT. Cables between CDN and EUT are as short as possible, and their height above the ground reference plane shall be between 30 and 50 mm (where possible).

The disturbance signal described below is injected to EUT through CDN.

The EUT operates within its operational mode(s) under intended climatic conditions after power on.

Use the frequency range specified by the standard, interference signal level, and interference signal for testing.

The step size shall not exceed 1% of the start and thereafter 1% of the preceding frequency value.

Recording the EUT operating situation during compliance testing and decide the EUT immunity criterion.

## 10.6. Test result

Test Site: 6#EMC Shield Room	Test Date: 2025/10/09--2025/10/09
Condition: 23.1°C,63.7%RH	Test Engineer: Liu Xuhui
Memo: /	

EUT Name: PORTABLE BLUETOOTH SPEAKER		EUT Model: GO5D			
Sample No.: S25091711-003		Test Mode: Charging + Bluetooth mode			
Power supply: AC 230V/50Hz		Memo:/			
Test steps: 1%, Dwell time 1s, 0.4kHz 80% AM modulation					
Test frequency	Injected Position	Strength	Required	Observation	Result
0.15MHz to 80MHz	AC Port	3V	A	A	Pass
Observation Description: A: Normal performance within limits specified by the manufacturer requestor or purchaser.					

EUT Name: PORTABLE BLUETOOTH SPEAKER		EUT Model: GO5D			
Sample No.: S25091711-003		Test Mode: Charging + Bluetooth + TWS mode			
Power supply: AC 230V/50Hz		Memo:/			
Test steps: 1%, Dwell time 1s, 0.4kHz 80% AM modulation					
Test frequency	Injected Position	Strength	Required	Observation	Result
0.15MHz to 80MHz	AC Port	3V	A	A	Pass
Observation Description: A: Normal performance within limits specified by the manufacturer requestor or purchaser.					

## 10.7. Test photo

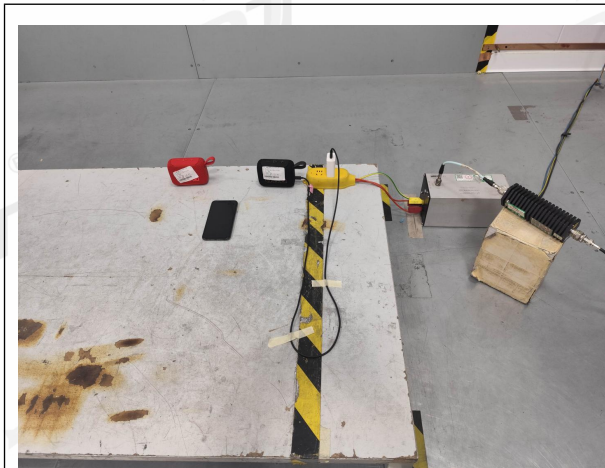

/

/

## 11. Voltage Dips and Interruptions Test

### 11.1. Test equipment

Equipment	Manufacturer	Model No.	Equipment No.	Cal. Due to
EFT Generator	EMC Partner	TRA3000F	DDT-ZC00546	2026/03/28
DIPS TESTER	EMC Partner	EXT-TRA3000D	DDT-ZC00548	2026/03/28

### 11.2. Block diagram of test setup

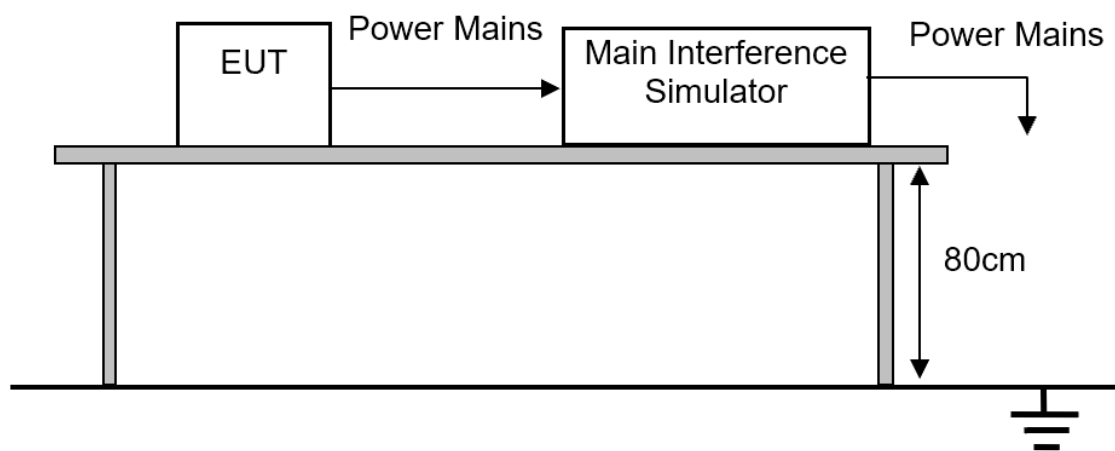

### 11.3. Test levels and performance criterion

Test Level %UT	Voltage dip and short interruptions %UT	Duration (in period)	Performance Criterion
0	100	0.5	B
0	100	1	B
70	30	25 for 50 Hz/30 for 60 Hz	C(note)
0	100	250 for 50 Hz/300 for 60 Hz	C

Note: in the case where the equipment is fitted with or connected to a battery back-up, the performance criteria for transient phenomena shall apply as specified in clause 6.2 of ETSI EN 301 489-1.

#### 11.4. Assistant equipment used for test

Assistant equipment	Manufacturer	Model number	Description	other
Adapter	HUAWEI	HW-100400C01	Huawei fast charging 66W-1#/2# site	Input: 100-240V~ 50/60Hz, Output: 5V/2A or 9V/2A or 10V/4A MAX
USB cable	N/A	N/A	Length: 1m	N/A
PORTABLE BLUETOOTH SPEAKER	Harman	GO5D	N/A	N/A
Mobile Phone	HUAWEI	HMA-AL00	Huawei Phone-Mate 20	N/A

#### 11.5. Test procedure

The EUT and test generator were setup as shown. The interruptions are introduced at selected phase angles with specified duration. Record any degradation of performance.

#### 11.6. Test result

Test Site: 7#EMC Shield Room	Test Date: 2025/10/09--2025/10/09
Condition: 22°C,45%RH	Test Engineer: Hans Xu
Memo: /	

EUT Name: PORTABLE BLUETOOTH SPEAKER			EUT Model: GO5D		
Sample No.: S25091711-003			Test Mode: Charging + Bluetooth mode		
Power supply: AC 240V/50Hz			Memo: /		
Voltage Dips & Short Interruptions %U <sub>T</sub>	Duration (in period)	Phase Angle	Required	Observation	Result
0	0.5P	0° to 360°	B	A	Pass
0	1P	0° to 360°	B	A	Pass
70	25P	0° to 360°	C	A	Pass
0	250P	0° to 360°	C	B	Pass
Observation Description:					
A: Normal performance within limits specified by the manufacturer requestor or purchaser.					
B: During the test, the prototype's charging indicator light goes out, and after the test is completed, it can return to normal operation on its own.					

EUT Name: PORTABLE BLUETOOTH SPEAKER			EUT Model: GO5D		
Sample No.: S25091711-003			Test Mode: Charging + Bluetooth mode		
Power supply: AC 100V/60Hz			Memo: /		
Voltage Dips & Short Interruptions %U <sub>T</sub>	Duration (in period)	Phase Angle	Required	Observation	Result
0	0.5P	0° to 360°	B	A	Pass
0	1P	0° to 360°	B	A	Pass
70	30P	0° to 360°	C	A	Pass
0	300P	0° to 360°	C	B	Pass
<b>Observation Description:</b> A: Normal performance within limits specified by the manufacturer requestor or purchaser. B: During the test, the prototype's charging indicator light goes out, and after the test is completed, it can return to normal operation on its own.					

EUT Name: PORTABLE BLUETOOTH SPEAKER			EUT Model: GO5D		
Sample No.: S25091711-003			Test Mode: Charging + Bluetooth + TWS mode		
Power supply: AC 240V/50Hz			Memo: /		
Voltage Dips & Short Interruptions %U <sub>T</sub>	Duration (in period)	Phase Angle	Required	Observation	Result
0	0.5P	0° to 360°	B	A	Pass
0	1P	0° to 360°	B	A	Pass
70	25P	0° to 360°	C	A	Pass
0	250P	0° to 360°	C	B	Pass
<b>Observation Description:</b> A: Normal performance within limits specified by the manufacturer requestor or purchaser. B: During the test, the prototype's charging indicator light goes out, and after the test is completed, it can return to normal operation on its own.					

EUT Name: PORTABLE BLUETOOTH SPEAKER			EUT Model: GO5D		
Sample No.: S25091711-003			Test Mode: Charging + Bluetooth + TWS mode		
Power supply: AC 100V/60Hz			Memo: /		
Voltage Dips & Short Interruptions %U <sub>T</sub>	Duration (in period)	Phase Angle	Required	Observation	Result
0	0.5P	0° to 360°	B	A	Pass
0	1P	0° to 360°	B	A	Pass
70	30P	0° to 360°	C	A	Pass
0	300P	0° to 360°	C	B	Pass
<p>Observation Description:</p> <p>A: Normal performance within limits specified by the manufacturer requestor or purchaser.</p> <p>B: During the test, the prototype's charging indicator light goes out, and after the test is completed, it can return to normal operation on its own.</p>					

### 11.7. Test photo



## 12. Sample photos

Please refer to DDT-Q25091711-2E Appendix I.

-----End Report-----