

STRONG

simpliONE Box Antenne
SRT4250



Powered by
androidtv



Installationsanleitung



www.strong.tv



1



2

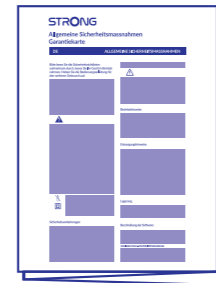

3



Bedienungsanleitung: www.strong.tv



2xAAA

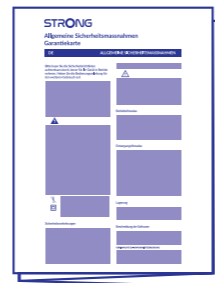

1.

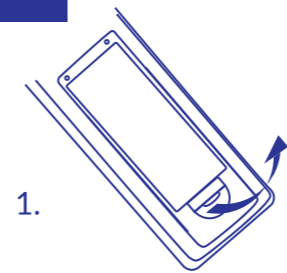

2.

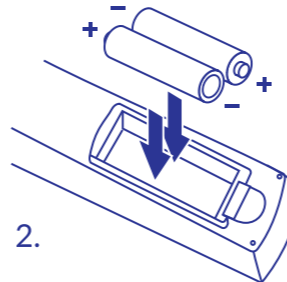

3.

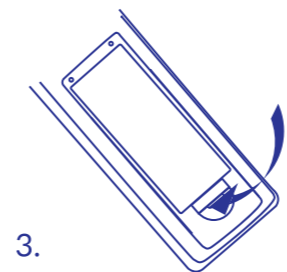

2.

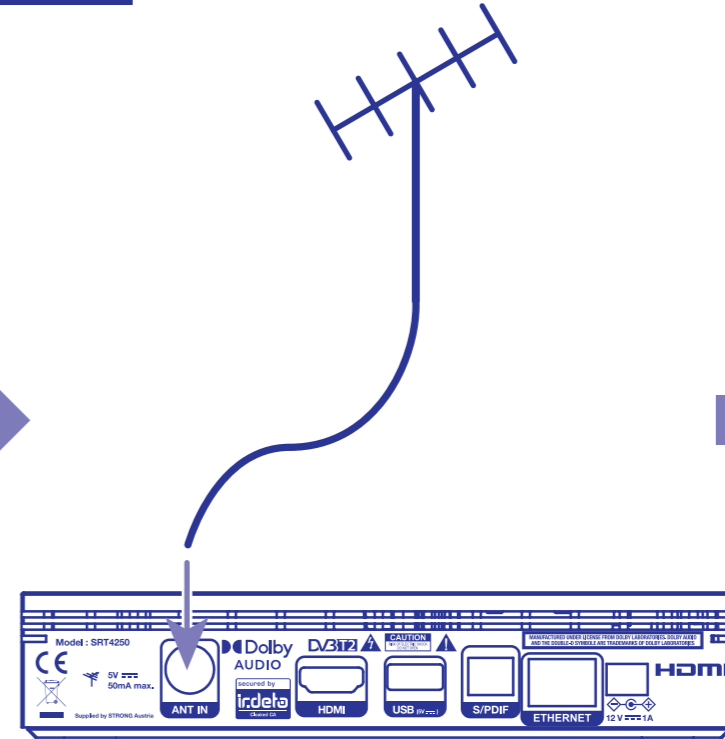

SERVICE CENTER

AT support_at@strong.tv
0820 400 150
(€ 0,12/Min. österr. Festnetz)

3.

4.

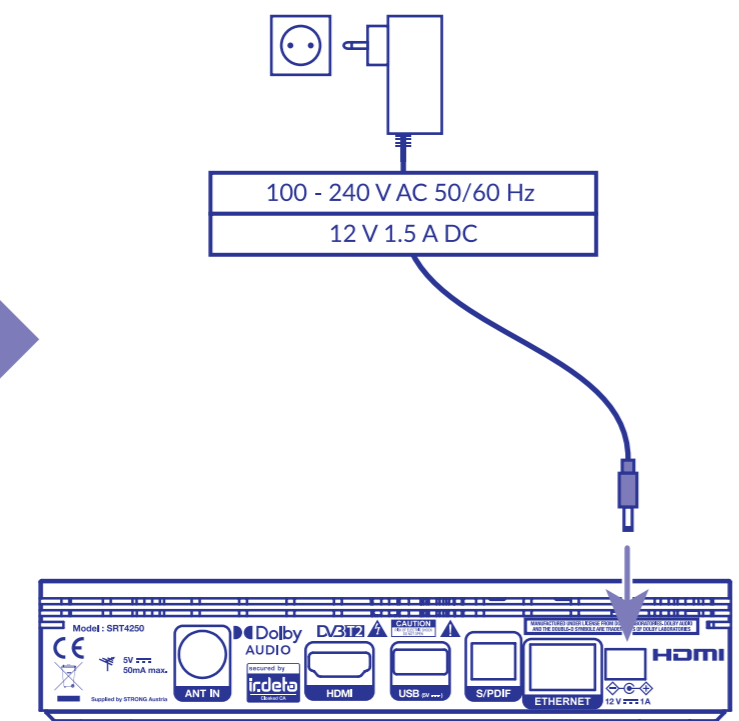
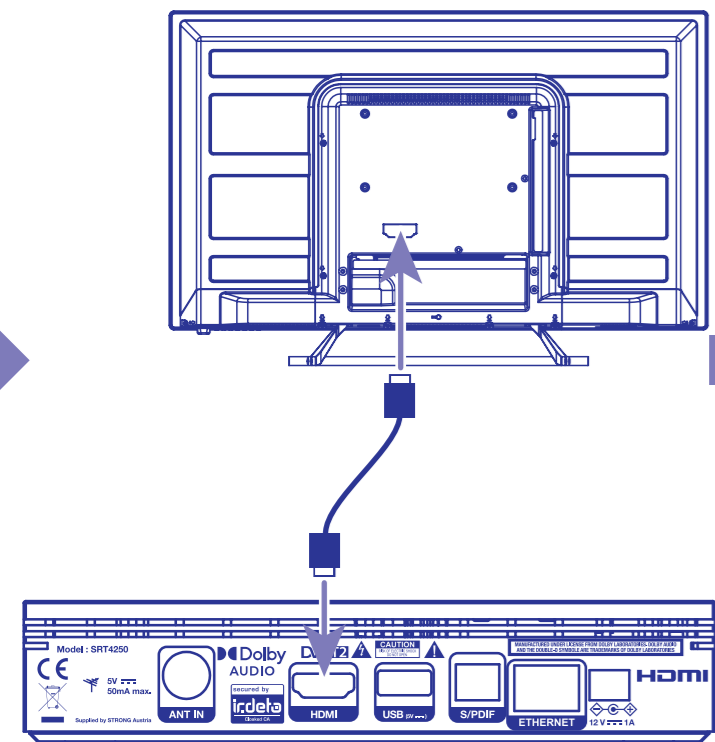

0 ~ +40 °C (Umgebungstemperatur)

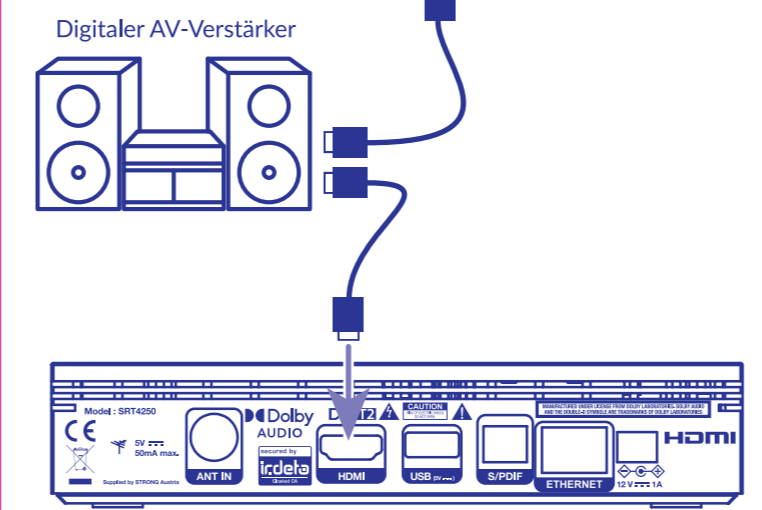
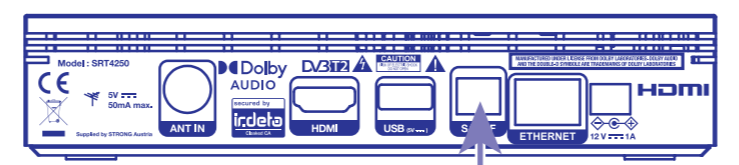

Option 1: WLAN (Wifi)

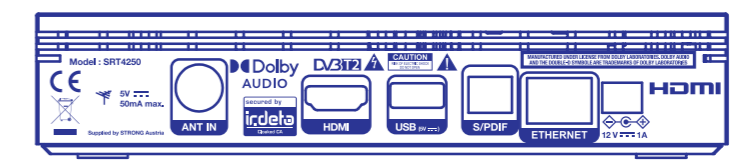

Option 2: LAN (Ethernet)

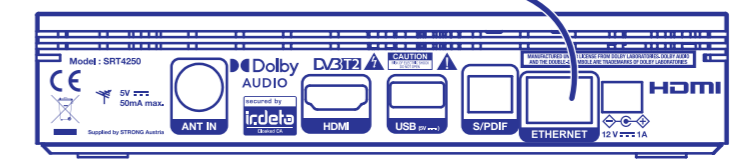
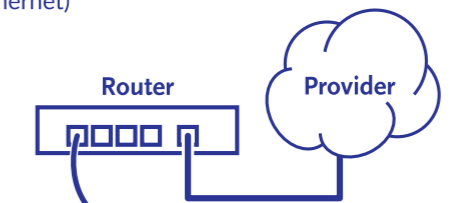

HDMI™ Dolby Audio DVB-T2 Chromecast built-in

Irrtum und technische Änderungen vorbehalten. In Folge kontinuierlicher Forschung und Entwicklung können sich Spezifikationen, Form und Aussehen der Produkte ändern. Die Begriffe HDMI und HDMI High-Definition Multimedia Interface sowie das HDMI-Logo sind Marken oder eingetragene Marken von HDMI Licensing Administrator, Inc. in den Vereinigten Staaten und anderen Ländern. In Lizenz von Dolby Laboratories gefertigt. Dolby Audio, Dolby Digital, Dolby Digital Plus und das Doppel-D-Symbol sind Warenzeichen von Dolby Laboratories. Alle anderen Produktnamen sind Warenzeichen oder eingetragene Warenzeichen ihrer jeweiligen Eigentümer. © STRONG 2023. Alle Rechte vorbehalten.

Google, Google Play, YouTube, Android TV and other marks are trademarks of Google LLC.

VEREINFACHTE EU KONFORMITÄTSERKLÄRUNG
 STRONG erklärt hiermit, dass das Gerät SRT4250 konform der Richtlinie 2014/53 / EU entspricht.
 Der vollständige Wortlaut der EU-Konformitätserklärung steht unter folgender Internetadresse zur Verfügung: <http://www.strong.tv/en/doc>

Geliefert durch STRONG Austria. Vertreten durch STRONG Ges.m.b.H. Teinfaltstraße 8/4. Stock, 1010 Wien, Österreich. Email: support_at@strong.tv